

STRIPES sofa 9SS305 cm 145x73x133h in Camira fabric cat. B art. Xtreme Plus col. Panama YS079, with OPM1 shiny chrome metal base.



STRIPES customized composition cm 900x73x133h in leather cat. Super art. Dollaro col. 7290, with RAL 9006 white aluminium painted metal bases.





Front sofa: **STRIPES** sofa 9SS208 cm 185x73x133h with external part in Camira fabric cat. E art. Blazer II col. Silverdale CUZ28, seat in fabric cat. B Xtreme Plus col. Diablo YS101 and backrest in fabric cat. B art. Xtreme Plus col. Panama YS079; OPM1 shiny chrome metal base.

STRIPES Y-shaped **composition "A"** made of 2 elements with left armrest and 2 elements with right armrest 9SS604 cm 225/185x73x101h with an angle of 60° in Gabriel fabric cat. B art. Atlantic col. 64116, 2 low shelves 9SS809 in HPL in colour 1661 and small cushions 9RL112 cm 63x33 in fabric cat. B art. Atlantic col. 62048, with OPM6 RAL 9017 black painted metal bases. Belux lamps 9SS805, Schulte Evoline socket 9SS802, mobile shelf 9SS806 and mobile socket 9SS801. **PIVOT** swivel armchair 9PIV101 cm 55.5x54x80h with natural oak structure and seat and back in fabric cat. B art. Atlantic in the colours 64116 red and 62048 green; **PIVOT** tables 7PIV101 ø cm 60x43/61h in natural oak.

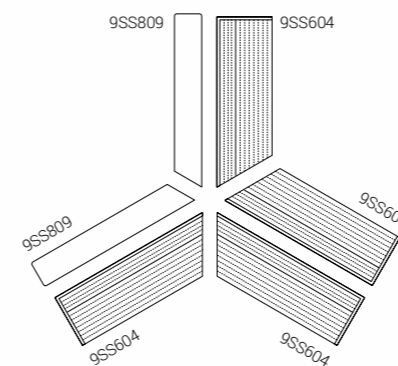



STRIPES Y-shaped composition "A"

made of 2 elements with left armrest and 2 elements with right armrest 9SS604 cm 225/185x73x101h with an angle of 60° in Gabriel fabric cat. B art. Atlantic col. 64116, 2 low shelves 9SS809 in HPL in colour 1661 and small cushions 9RL112 cm 63x33 in fabric cat. B art. Atlantic col. 62048, with OPM6 RAL 9017 black painted metal bases. Belux lamps 9SS805, Schulte Evoline socket 9SS802, mobile shelf 9SS806 and mobile socket 9SS801. **PIVOT** swivel armchair 9PIV101 cm 55.5x54x80h with natural oak structure and seat and back in fabric cat. B art. Atlantic in the colours 64116 red and 62048 green; **PIVOT** tables 7PIV101 ø cm 60x43/61h in natural oak.

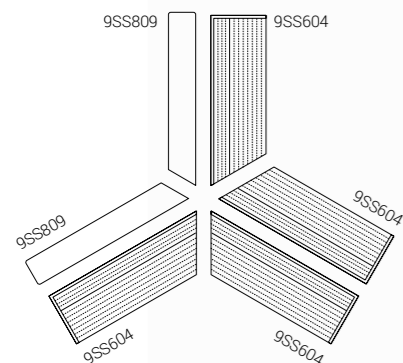

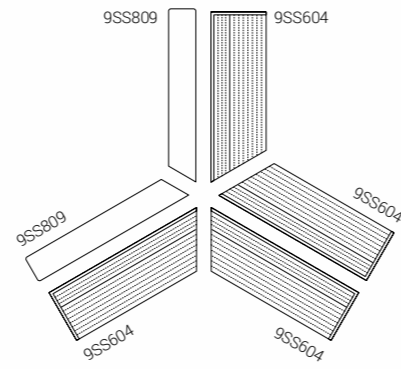

STRIPES Y-shaped **composition "A"** made of 2 elements with left armrest and 2 elements with right armrest 9SS604 cm 225/185x73x101h with an angle of 60° in Gabriel fabric cat. B art. Atlantic col. 64116, 2 low shelves 9SS809 in HPL in colour 1661 and small cushions 9RL112 cm 63x33 in fabric cat. B art. Atlantic col. 62048, with OPM6 RAL 9017 black painted metal bases. Belux lamps 9SS805, Schulte Evoline socket 9SS802, mobile shelf 9SS806 and mobile socket 9SS801. **PIVOT** swivel armchair 9PIV101 cm 55.5x54x80h with natural oak structure and seat and back in fabric cat. B art. Atlantic in the colours 64116 red and 62048 green; **PIVOT** tables 7PIV101 ø cm 60x43/61h in natural oak.



Detail of **STRIPES** Y-shaped **composition "A"** in Gabriel fabric cat. B art. Atlantic col. 64116 with low shelves 9SS809 in HPL in colour 1661, Belux lamps 9SS805, Schulte Evoline sockets 9SS802, mobile socket 9SS801 and **PIVOT** swivel armchair 9PIV101 with back and seat in fabric cat. B art. Atlantic col. 64116 and structure in natural oak.





Detail of mobile socket 9SS801
on **STRIPES composition "A"**
in Gabriel fabric cat. B
art. Atlantic col. 64116.

STRIPES curved **composition "B"** with diameter cm 370 made of 2 curved elements with 1 arm 9SS908 and 1 curved element without arm 9SS907 in Gabriel fabric cat. B art. Atlantic col. 64116 with small cushions 9RL112 in the same fabric colour and in colour 61163. OPM6 RAL 9017 black painted metal bases.
PIVOT table 7PIV101 ø cm 60xh43/61 in natural oak.

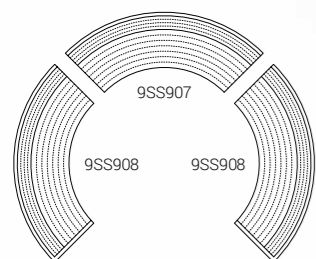
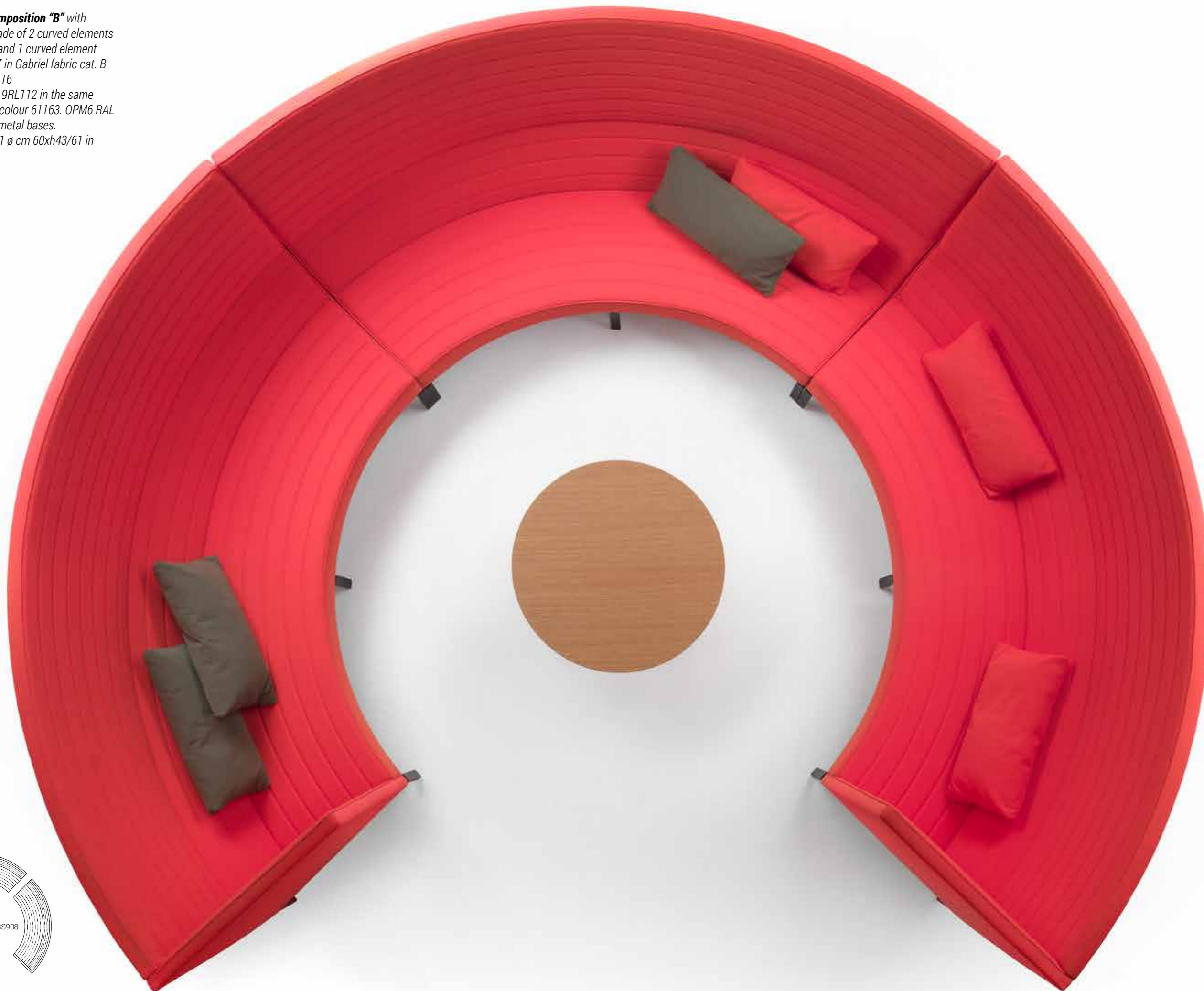

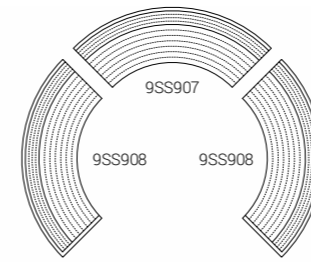

STRIPES curved **composition "B"** with diametre cm 370 made of 2 curved elements with 1 arm 9SS908 and 1 curved element without arm 9SS907 in Gabriel fabric cat. B art. Atlantic col. 64116 with small cushions 9RL112 in the same fabric colour and in colour 61163. OPM6 RAL 9017 black painted metal bases.
PIVOT table 7PIV101 ø cm 60xh43/61 in natural oak.





STRIPES composition "C" made of 2 sofas 9SS208 cm 185x73x133h in Gabriel fabric cat. B art. Atlantic col. 61163 with cushions 9RL112 cm 63x33 in fabric cat. B art. Atlantic col. 66086 with high shelf 9SS808 and table 9SS404X cm 82x133x133h in HPL in colour 1661. OPM6 black painted metal bases. Bachmann Power Frame electric module 9SS803, mobile lamp 9SS804, Belux lamp 9SS805 and Schulte Evoline socket 9SS802.

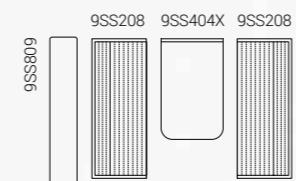
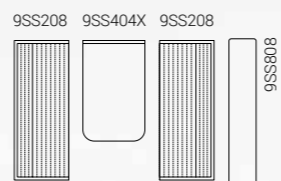

STRIPES composition "C" made of 2 sofas 9SS208 cm 185x73x133h in Gabriel fabric cat. B art. Atlantic col. 61078 with cushions 9RL112 cm 63x33 in fabric cat. B art. Atlantic col. 66086 with low shelf 9SS809 and table 9SS404X cm 82x133x133h in HPL in colour 1661. OPM6 black painted metal bases. Bachmann Power Frame electric module 9SS803, mobile lamp 9SS804, Belux lamp 9SS805 and Schulte Evoline socket 9SS802. **PIVOT** swivel armchair 9PIV101 cm 55.5x54x80h with natural oak structure and seat and back in fabric cat. B art. Atlantic col. 66086.

STRIPES composition "C" made of 2 sofas 9SS208 cm 185x73x133h in Gabriel fabric cat. B art. Atlantic col. 61078, with cushions 9RL112 cm 63x33 in fabric cat. B art. Atlantic col. 66086 with low shelf 9SS809 and table 9SS404X cm 82x133x133h in HPL in colour 1661. OPM6 black painted metal bases. Bachmann Power Frame electric module 9SS803, mobile lamp 9SS804, Belux lamp 9SS805 and Schulte Evoline socket 9SS802.

PIVOT swivel armchair 9PIV101 cm 55.5x54x80h with natural oak structure and seat and back in fabric cat. B art. Atlantic col. 66086.

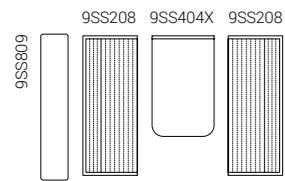

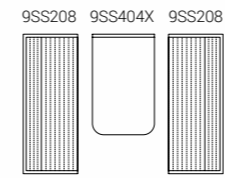

Detail of **STRIPES composition "C"** made of 2 sofas 9SS208 cm 185x73x133h in Gabriel fabric cat. B art. Atlantic col. 61078 with cushions 9RL112 cm 63x33 in fabric cat. B art. Atlantic col. 66086, with table 9SS404X cm 82x133x133h in HPL in colour 1661. Bachmann Power Frame electric module 9SS803 and mobile lamp 9SS804.



STRIPES sofa 9SS208 cm 185x73x133h in Gabriel fabric cat. B art. Atlantic col. 61163 with high shelf 9SS808 in HPL in colour 1661, with OPM6 RAL 9017 black painted metal base, Belux lamp 9SS805 and mobile socket 9SS801. **STRIPES composition "C"** made of 2 sofas 9SS208 cm 185x73x133h in Gabriel fabric cat. B art. Atlantic col. 61078, with table 9SS404X cm 82x133x133h and low shelf 9SS809 in HPL in colour 1661 and with cushions 9RL112 cm 63x33 in fabric cat. B art. Atlantic col. 64116. OPM6 black painted metal bases. Belux lamp 9SS805 and Schulte Evoline socket 9SS802. **PIVOT** swivel armchairs 9PIV101 cm 55.5x54x80h with natural oak structure and back and seat in fabric cat. B art. Atlantic col. 64116 and **PIVOT** table 7PIV101 ø cm 60x43/61 in natural oak.

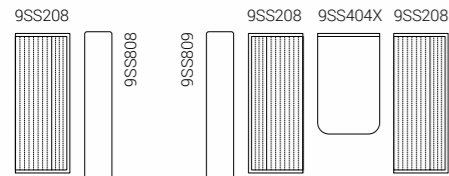

STRIPES composition "D" made of 2 sofas with 1 armrest 9SS210 cm 185x73x86h in Gabriel fabric cat. B art. Atlantic col. 61078 with low shelves 9SS809 in HPL in colour 1661, with OPM6 RAL 9017 black painted metal bases. Mobile shelf 9SS806, Belux lamps 9SS805 and mobile socket 9SS801. **PIVOT** swivel armchairs 9PIV101 cm 55.5x54x80h with natural oak structure and back and seat in fabric cat. B art. Atlantic col. 64116 red and 60063 beige and **PIVOT** table 7PIV101 ø cm 60x43/61 in natural oak.

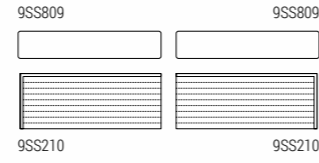

STRIPES composition "D" made of 2 sofas with 1 armrest 9SS210 cm 185x73x86h in Gabriel fabric cat. B art. Atlantic col. 61078 with low shelves 9SS809 in HPL in colour 1661, with OPM6 RAL 9017 black painted metal bases. Mobile shelf 9SS806, Belux lamps 9SS805 and mobile socket 9SS801. **PIVOT** swivel armchairs 9PIV101 cm 55.5x54x80h with natural oak structure and back and seat in fabric cat. B art. Atlantic col. 64116 red, 60063 beige and 61163 brown and **PIVOT** tables 7PIV101 ø cm 60x43/61 and 7PIV102 ø cm 78x43/74h in natural oak.

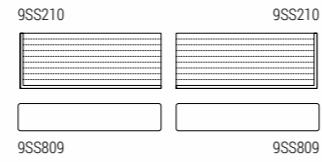

STRIPES composition "E" made of 2 corner elements 9SS401 cm 73x73x133h in Gabriel fabric cat. B art. Atlantic ol. 60063 beige, with OPM6 RAL 9017 black painted metal base and table 9SS405X cm 82x55x133h in HPL in colour 1661.

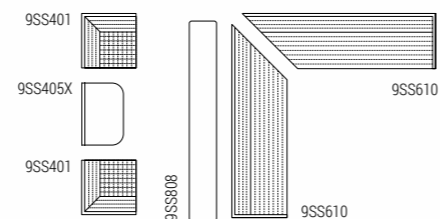

STRIPES composition "F" made of 2 sofas 9SS610 with 1 arm cm 255x73x133h with an angle of 45° in Gabriel fabric cat. B art. Atlantic col. 60063, with OPM6 RAL 9017 black painted metal bases. Small cushions 9RL112 cm 63x33 in fabric cat. B art. Atlantic col. 61163. High shelf 9SS808 in HPL in colour 1661 and Belux lamp 9SS805.

PIVOT swivel armchairs 9PIV101 55.5x54x80h with natural oak structure and seat and back in fabric cat. B art. Atlantic col. 60063 and 61163 and **PIVOT** tables 7PIV101 ø cm 60x43/61 and 7PIV102 ø cm 78x43/74h in natural oak.





STRIPES sofa with roof 9SS924 cm 185x73x183h in Gabriel fabric cat. B art. Atlantic col. 60063 with OPM6 RAL 9017 black painted metal base and **PIVOT** table 7PIV101 ø cm 60xh43/61 in natural oak.





STRIPES sofa 9SS305 cm 145x73x133h in Camira fabric cat. E art. Blazer col. Surrey CUZ1E with OPM6 RAL 9017 black painted metal base, with Bachmann Power Frame module 9SS807 and RAL 9017 black painted mobile writing shelf 9SS810.





STRIPES composition "G" made of 1 element 9SS401 cm 73x73x133h in Camira fabric cat. E art. Blazer col. Silcoates CUZ30 with RAL 9006 white aluminium painted base and 1 table 9SS403X cm 73x41x133h in white melamine with Bachmann Power Frame electric module 9SS803.



STRIPES composition "H" made of 2 elements 9SS401 cm 73x73x133h in Camira fabric cat. E art. Blazer col. Surrey CUZ1E with RAL 9006 white aluminium painted base and 1 table 9SS402X cm 82x55x133h in white melamine with Bachmann Power Frame electric module 9SS803.

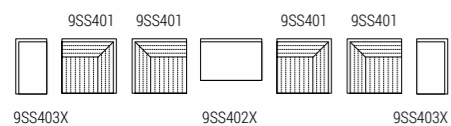

STRIPES composition made of 2 compositions "G" and 1 composition "H", as described above.



STRIPES sofas without arms 9SS201 cm 145x73x101h and bench 9SS101 cm 145x73x42.5h with vertical quilting in Camira fabric cat. E art. Blazer col. Silcoates CUZ30 with OPM6 RAL 9017 black painted metal bases. **STRIPES** sofas with 1 arm 9SS202 cm 145x73x101h with bench 9SS101 cm 145x73x42.5h with horizontal quilting in Camira fabric cat. E art. Blazer col. Bryanstom CUZ53 with OPM6 RAL 9017 black painted metal bases.



STRIPES is available with horizontal and, on demand, with vertical quilting.



STRIPES sofa without arms 9SS201 cm 145x73x101h and bench 9SS101 cm 145x73x42.5h with vertical quilting in Camira fabric cat. E art. Blazer col. Silcoates CUZ30 with OPM6 RAL 9017 black painted metal bases.

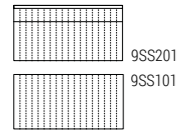

STRIPES sofas with 1 arm 9SS202 cm 145x73x101h in Camira fabric cat. E art. Blazer col. Bryanstom CUZ53 with OPM6 RAL 9017 black painted metal bases.

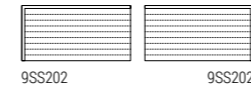

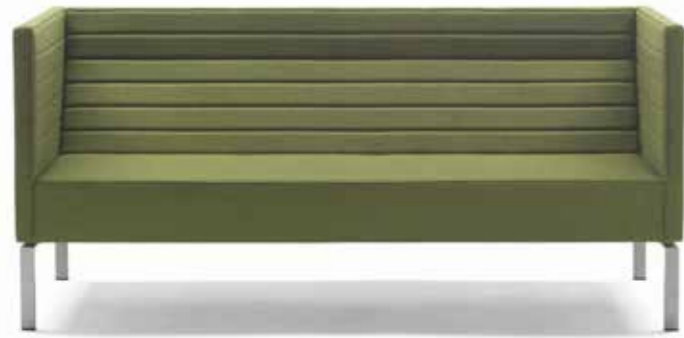

STRIPES sofa cm 145x73x86h in Camira fabric cat. E art. Blazer col. Bryanstom CUZ53 with RAL 9006 white aluminium painted metal base. **PIVOT** swivel armchair 9PIV101 55.5x54x80h with natural oak structure and seat and back in Camira fabric cat. E art. Blazer col. Silverdale CUZ28 and **PIVOT** table 7PIV101 ø cm 60x43/61 in natural oak.





STRIPES composition "J" made of 2 elements with 1 arm 9SS614 cm 225x73x101h with an angle of 60° and 1 element without arms 9SS615 cm 225x73x101h with an angle of 60° in Camira fabric cat. E art. Blazer col. Surrey CUZ1E, with OPM6 RAL 9017 black painted metal bases and back low shelves 9SS809 in HPL in colour 1661.

PIVOT swivel armchairs 9PIV101 55.5x54x80h with natural oak structure and seat and back in the same fabric and **PIVOT** tables 7PIV101 ø cm 60x43/61 and 7PIV102 ø cm 78x43/74h in natural oak.

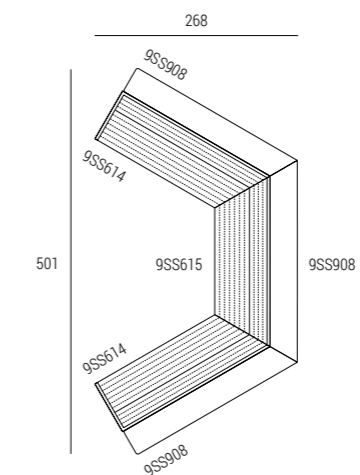

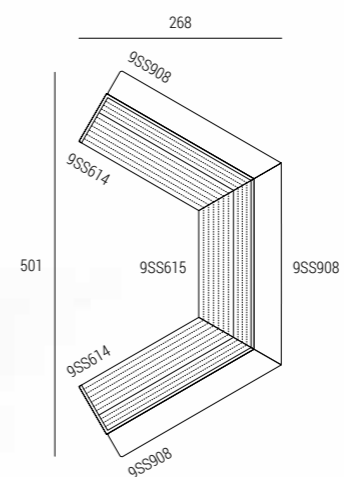
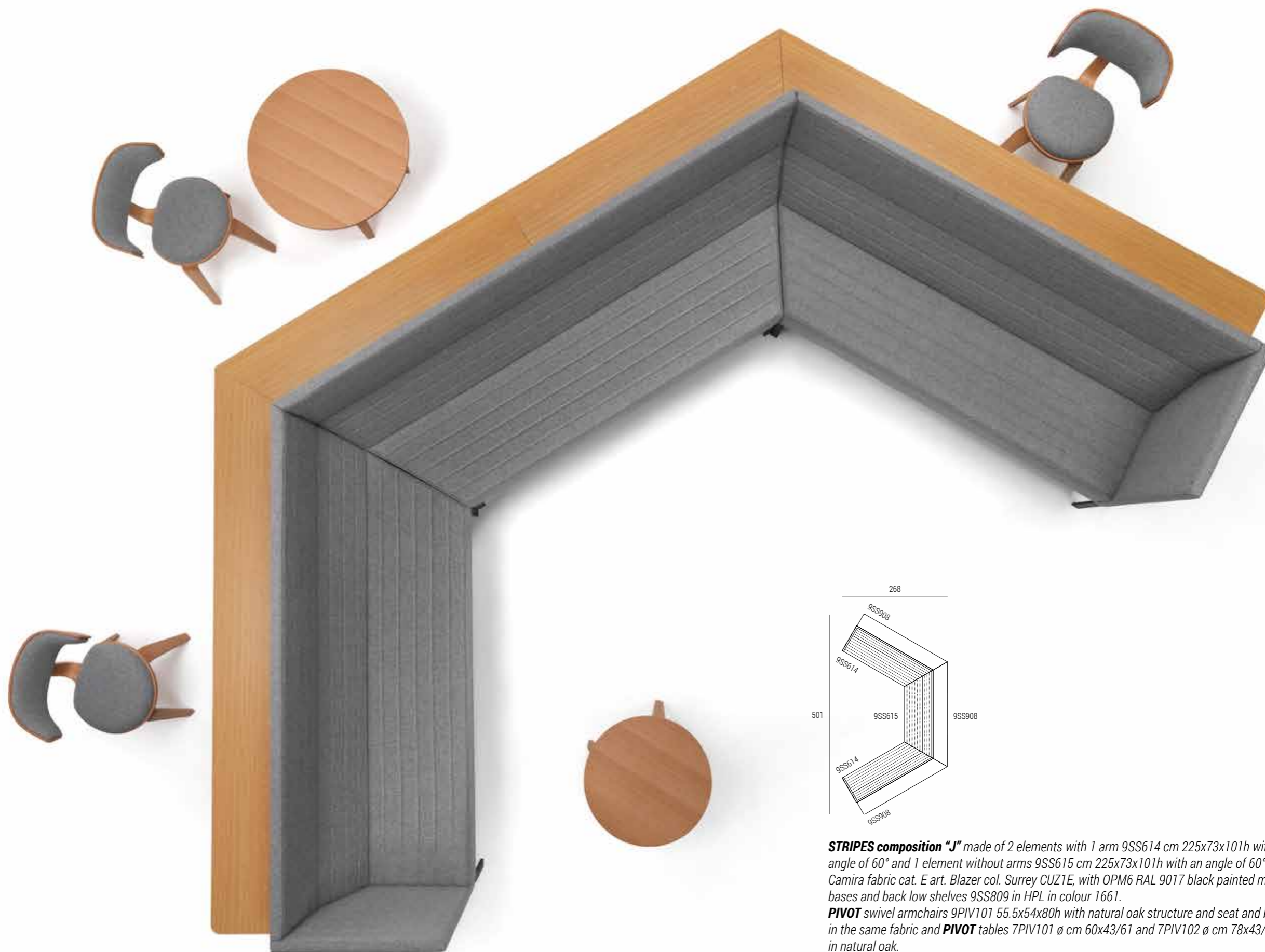

STRIPES composition "J" made of 2 elements with 1 arm 9SS614 cm 225x73x101h with an angle of 60° and 1 element without arms 9SS615 cm 225x73x101h with an angle of 60° in Camira fabric cat. E art. Blazer col. Surrey CUZ1E, with OPM6 RAL 9017 black painted metal bases and back low shelves 9SS809 in HPL in colour 1661.

PIVOT swivel armchairs 9PIV101 55.5x54x80h with natural oak structure and seat and back in the same fabric and **PIVOT** tables 7PIV101 ø cm 60x43/61 and 7PIV102 ø cm 78x43/74h in natural oak.

STRIPES composition "K" made of 1 sofa with 1 arm cm 185x73x133h, 1 curved element without arms 9SS909, 1 curved element without arms 9SS906 and 1 curved element without arms 9SS907 in Kvadrat fabric cat. H art. Steelcut Trio II col. 853, with OPM6 RAL 9017 black painted metal bases and low shelves 9SS809 in birch plywood natural oak veneered. Belux lamp 9SS805 and Schulte Evoline socket 9SS802.

PIVOT swivel armchair 9PIV101 55.5x54x80h with natural oak structure and seat and back in the same fabric and in Gabriel fabric cat. B art. Atlantic col. 61163 and **PIVOT** tables 7PIV101 ø cm 60x43/61 and 7PIV102 ø cm 78x43/74h in natural oak.

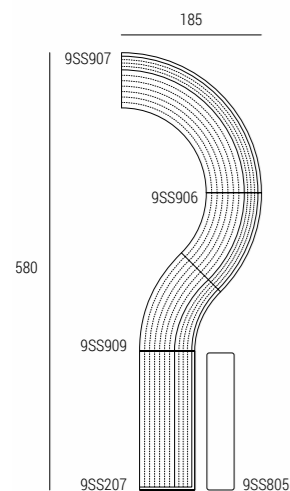

STRIPES composition "K" made of 1 sofa with 1 arm 9SS207 cm 185x73x133h, 1 curved element without arms 9SS909, 1 curved element without arms 9SS906 and 1 curved element without arms 9SS907 in Kvadrat fabric cat. H art. Steelcut Trio II col. 853, with OPM6 RAL 9017 black painted metal bases and low shelves 9SS809 in birch plywood natural oak veneered. Belux lamp 9SS805 and Schulte Evoline socket 9SS802. **PIVOT** swivel armchair 9PIV101 55.5x54x80h with natural oak structure and seat and back in the same fabric and in Gabriel fabric cat. B art. Atlantic col. 61163 and **PIVOT** tables 7PIV101 ø cm 60x43/61 and 7PIV102 ø cm 78x43/74h in natural oak.

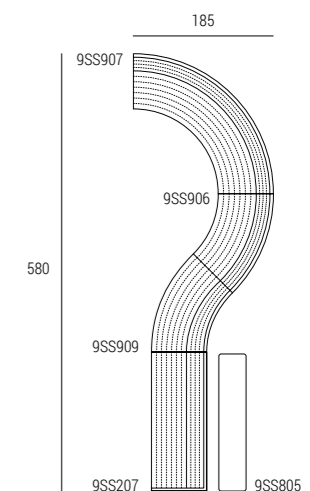

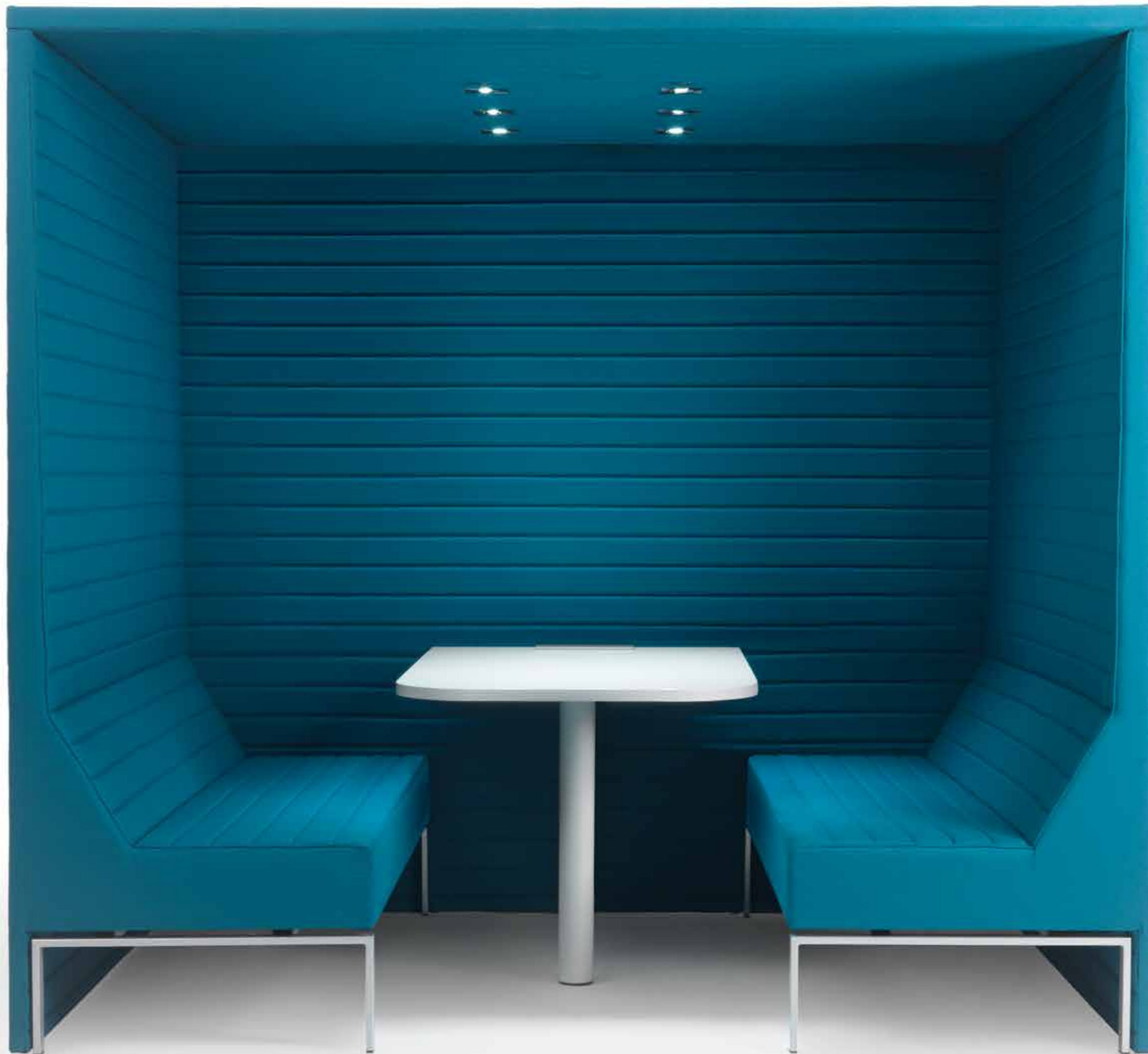

STRIPES box with led lighting 9SS916 cm
228x185x223h in Camira fabric cat. B art.
Xtreme Plus col. Tonga YS160 with OPM7
RAL 9016 white painted metal. Table in white
HPL and Bachmann power frame electric
module in the table 9SS803.

Activation of led lighting through motion
detector (standard version) or, on demand, by
means of a switch.

The standard equipment consists of 6 5W,
4000K, 420 Lumen LED spotlights, with
neutral white light and an angle of 45°.

<
 Detail of **STRIPES** box with led lighting
 9SS916 cm 228x185x223h.



STRIPES box 9SS917 cm 228x185x133h in Camira fabric cat. B art. Xtreme Plus col. Tonga YS160 with OPM7 RAL 9016 white painted metal. Table in white HPL and Bachmann power frame electric module in the table 9SS803.

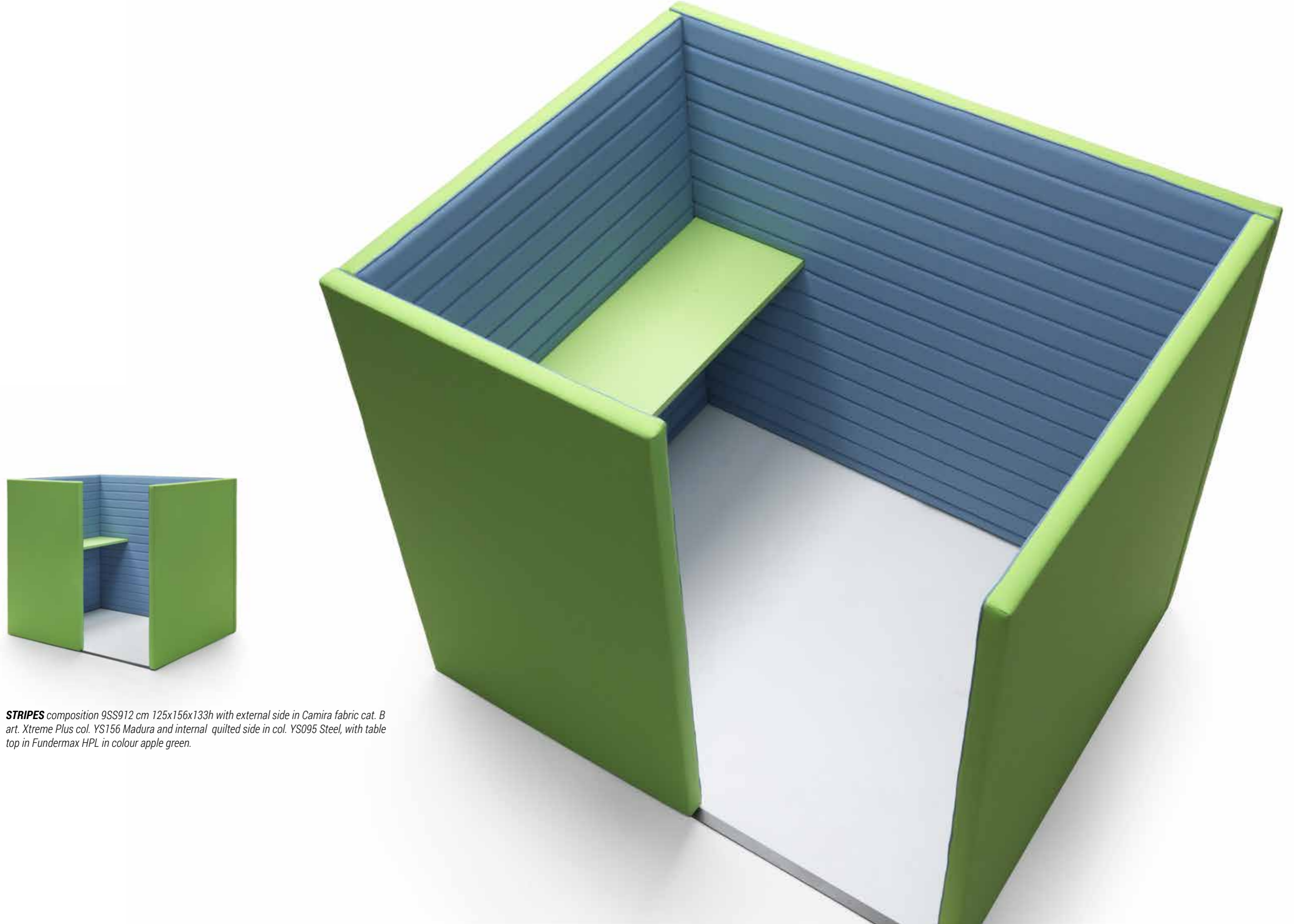

STRIPES composition 9SS912 cm 125x156x133h with external side in Camira fabric cat. B art. Xtreme Plus col. YS156 Madura and internal quilted side in col. YS095 Steel, with table top in Fundermax HPL in colour apple green.

STRIPES element 9SS913 cm 100x73x215h with external side in Camira fabric cat. B art. Xtreme Plus col. YS156 Madura and top and internal quilted side in col. YS095 Steel, with table top in Fundermax HPL in colour apple green and Bachmann Power Frame electric module 9SS803.

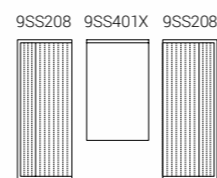

>
STRIPES composition "L" made of 2 sofas 9SS208 cm 185x73x133h with external side in Camira fabric cat. B art. Xtreme Plus col. YS156 Madura and internal quilted side in col. YS095 Steel, with table 9SS401X cm 82x133x133h top in Fundermax HPL in colour apple green and Bachmann Power Frame electric module 9SS803. OPM6 RAL 9017 black painted metal bases.

STRIPES element 9SS915 cm 228x185x133h and 2 elements 9SS914 cm 185x73x133h in the same fabrics.

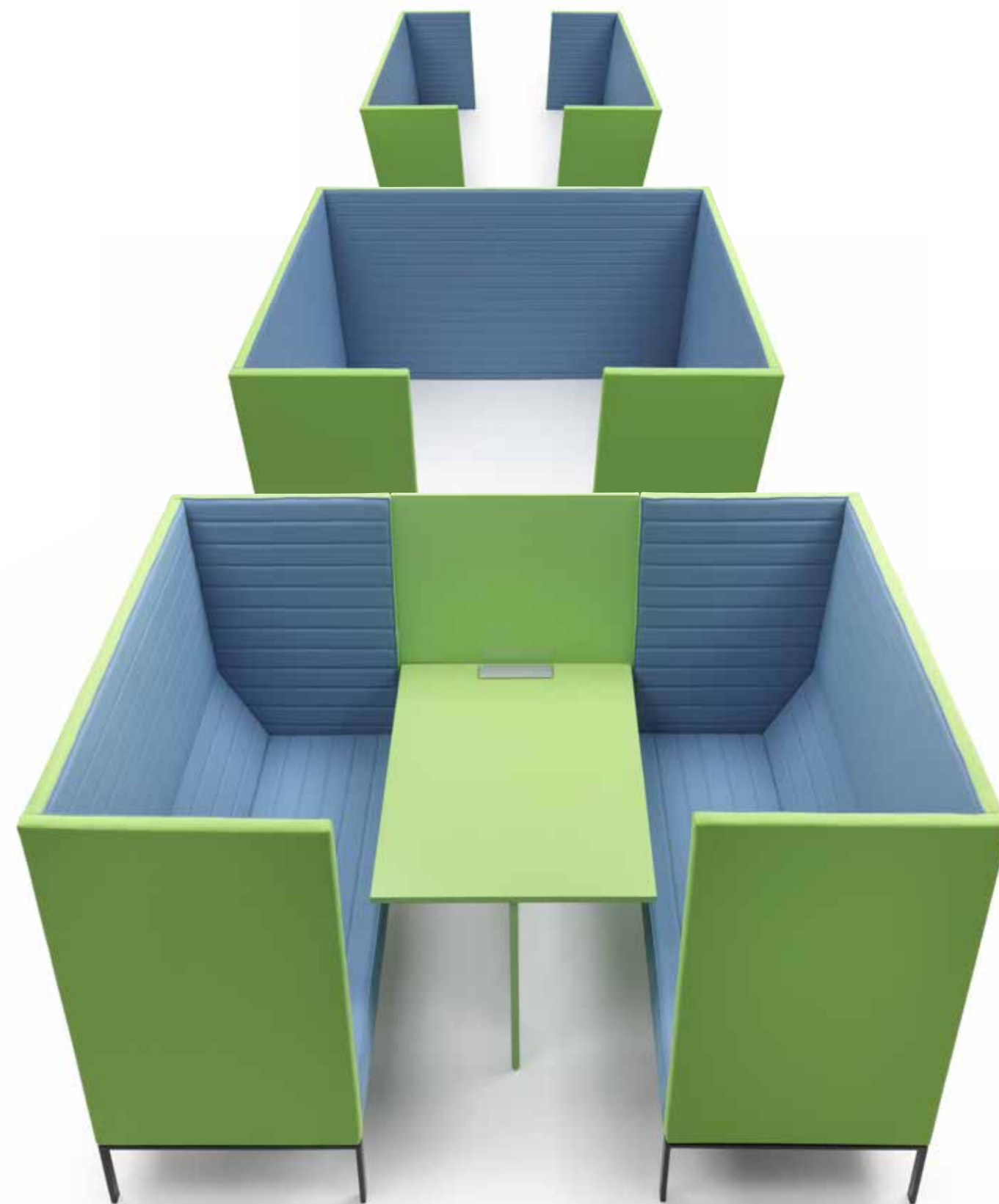



STRIPES armchairs 9SS107 cm 80x73x133h in Camira fabric cat. B art. Xtreme Plus col. Havana YS009 with OPM1 shiny chrome metal bases.



STRIPES swivel armchair 9SS108 cm 80x73x133h in Camira fabric cat. B art. Xtreme Plus col. Havana YS009 with OPM1 shiny chrome metal base.

Stripes

Design Jérôme Gauthier 2009

Available widths

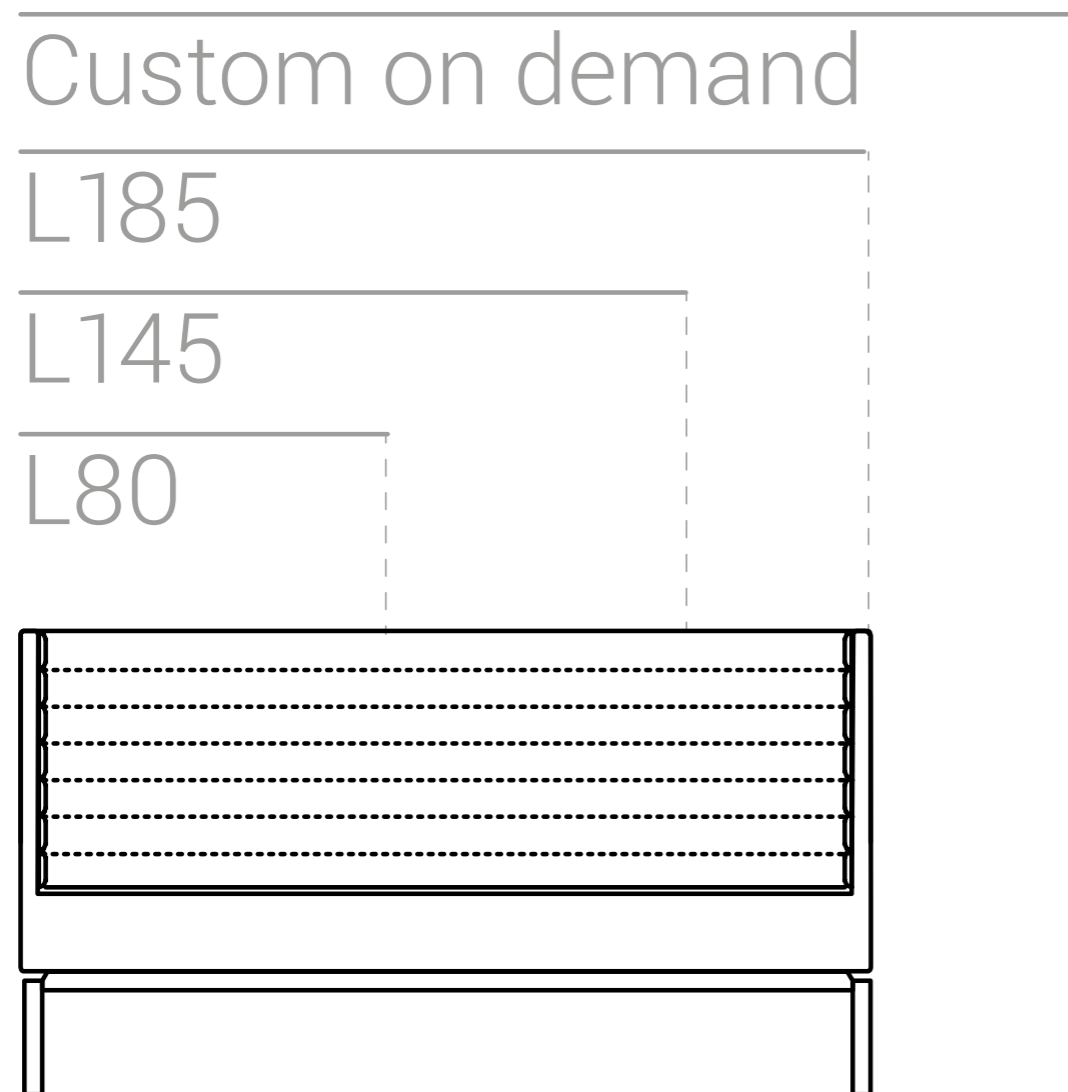

Stripes

Design Jérôme Gauthier 2009

Available heights

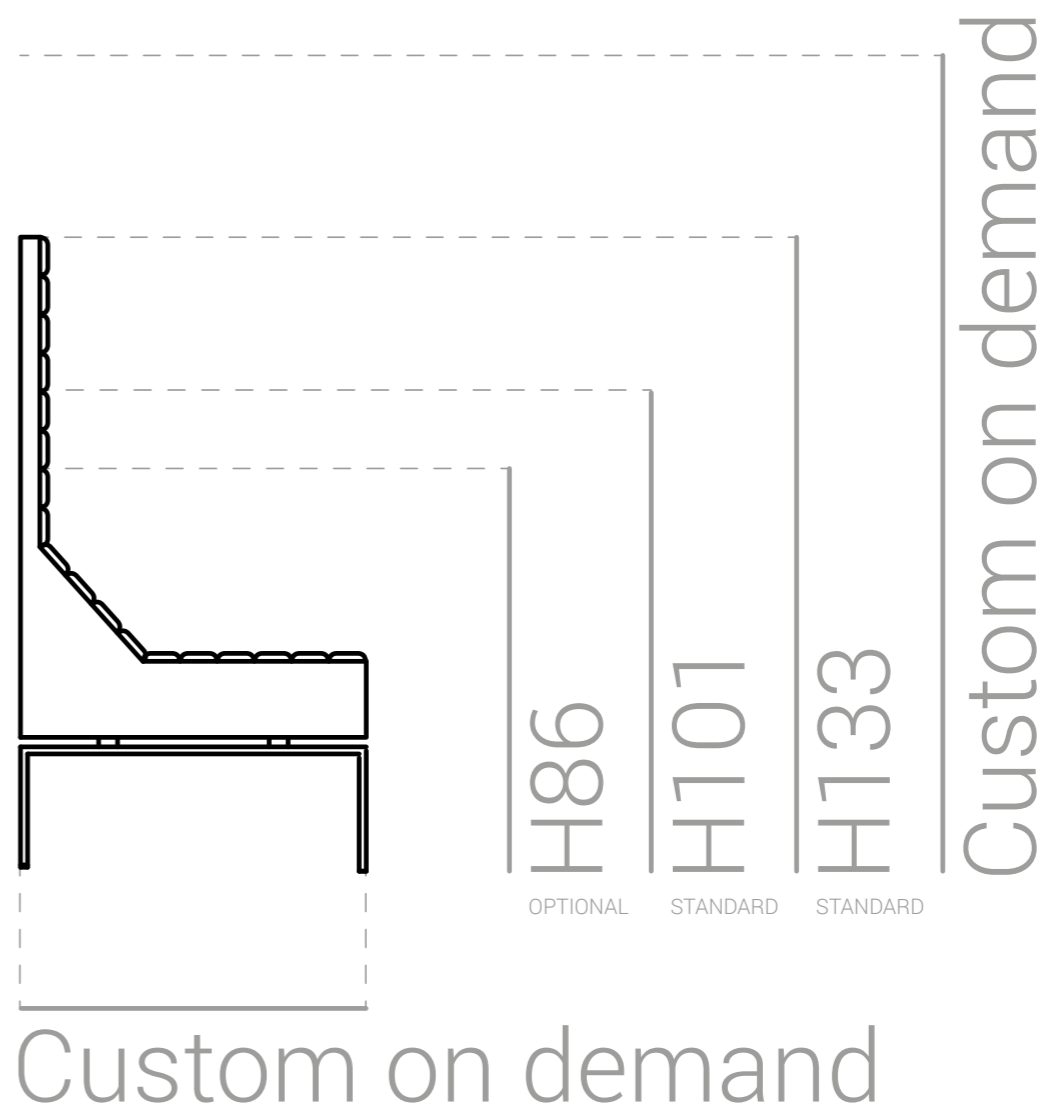

Stripes

Design Jérôme Gauthier 2009

Sofas

H101

9SS112
L80 P73 H101

9SS114
L120 P73 H101

9SS113
L80 P73 H101
Swivel armchair

9SS505
L73 P73 H101
Corner element

9SS201
L145 P73 H101

9SS202
L145 P73 H101

9SS204
L145 P73 H101

9SS209
L185 P73 H101

9SS210
L185 P73 H101

9SS212
L185 P73 H101

H133

9SS107
L80 P73 H133

9SS304
L120 P73 H133

9SS108
L80 P73 H133
Swivel armchair

9SS401
L73 P73 H133
Corner element

9SS301
L145 P73 H133

9SS303
L145 P73 H133

9SS305
L145 P73 H133

9SS205
L185 P73 H133

9SS207
L185 P73 H133

9SS208
L185 P73 H133

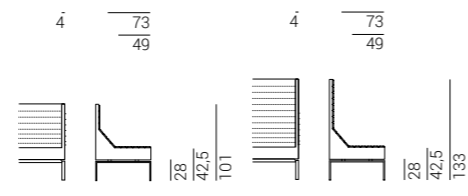

Stripes

Design Jérôme Gauthier 2009

Accessories

9RL112
L63 H33
Feather cushion without band

9SS101
L145 P73 H42,5

9SS103
L185 P73 H42,5

9SS102
L60 P30 H62
Horizontally adjustable server with metal top

9SS104
L73 P73 H37
Small table with transparent glass top

	RAL 9017 black painted metal	RAL 9016 White painted metal	Classic bronze painted metal	RAL 9006 Aluminium painted metal			
Code	OPM6	OPM7	OPM9				
Standard base finishes	●	●	●	●			
	Shiny chrome metal	Brushed matt chrome metal	Brushed matt dark grey metal	Brushed copper metal	Brushed antique brass metal	Shiny black chrome metal	Brushed antique gold metal
Code	OPM1	OPM2	OPM3	OPM12	OPM13	OPM14	OPM15
Optional base finishes	●	●	●	●	●	●	●
							Metal painted in RAL Classic colours

Stripes

Design Jérôme Gauthier 2009

Tables
25 mm thick

Tables

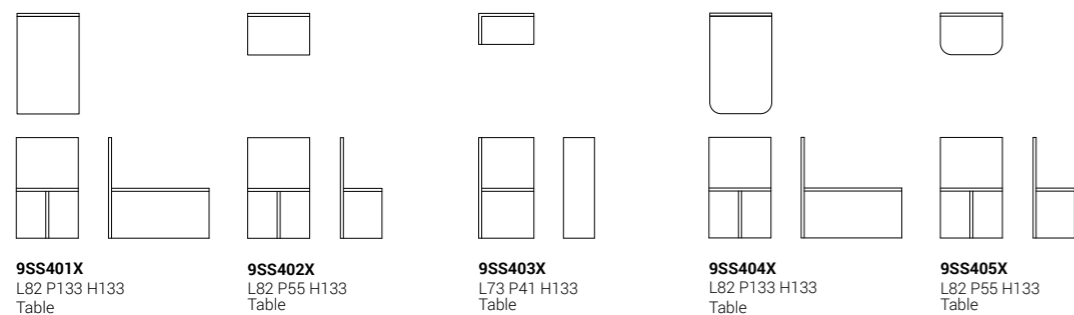

9SS401X
L82 P133 H133
Table

9SS402X
L82 P55 H133
Table

9SS403X
L73 P41 H133
Table

9SS404X
L82 P133 H133
Table

9SS405X
L82 P55 H133
Table

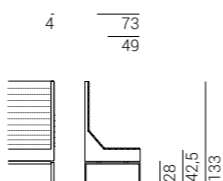
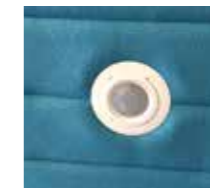

Table finishes	Melamine (standard)	HPL (optional)	Birch plywood oak veneered (optional)
	●	●	●

Stripes

Design Jérôme Gauthier 2009



* Activation of led lighting through motion detector (standard version) or, on demand, by means of a switch.

Box

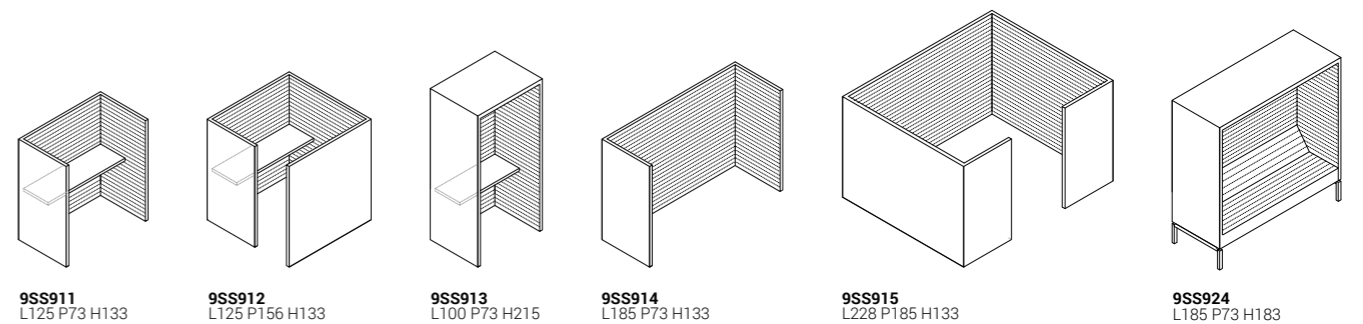

9SS911
L125 P73 H133

9SS912
L125 P156 H133

9SS913
L100 P73 H215

9SS914
L185 P73 H133

9SS915
L228 P185 H133

9SS924
L185 P73 H183

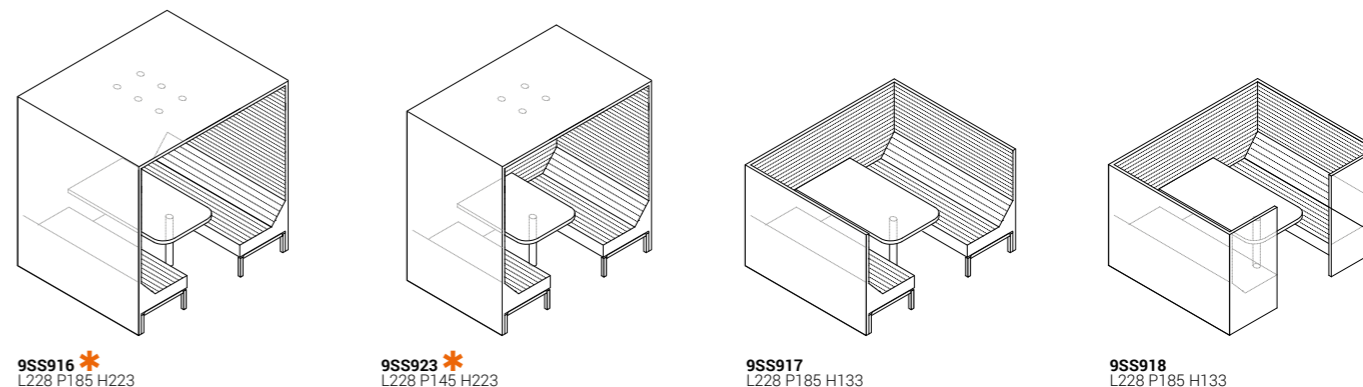

9SS916 *
L228 P185 H223

9SS923 *
L228 P145 H223

9SS917
L228 P185 H133

9SS918
L228 P185 H133

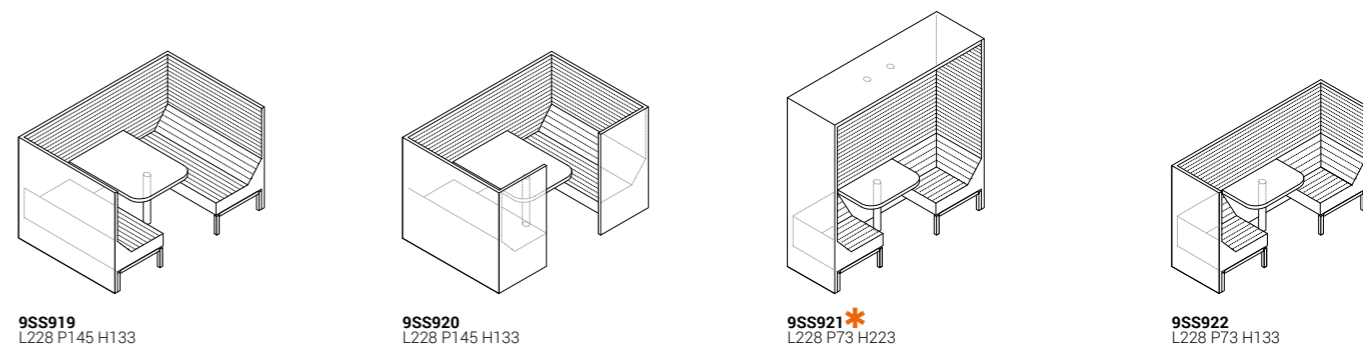

9SS919
L228 P145 H133

9SS920
L228 P145 H133

9SS921 *
L228 P73 H223

9SS922
L228 P73 H133

Configuration for wall screen available on demand.

Code	RAL 9017 black painted metal OPM6	RAL 9016 White painted metal OPM7	Classic bronze painted metal OPM9	RAL 9006 Aluminium painted metal
Standard base finishes	●	●	●	●
Code	Shiny chrome metal OPM1	Brushed matt chrome metal OPM2	Brushed matt dark grey metal OPM3	Brushed copper metal OPM12
Optional base finishes	●	●	●	●
				Brushed antique brass metal OPM13
				Shiny black chrome metal OPM14
				Brushed antique gold metal OPM15
				Metal painted in RAL Classic colours

Stripes

Design **Jérôme Gauthier** 2009

Optionals



9SS801 *
L11 P5 H31
Bachmann power frame mobile module



9SS802 **
L10 H10
Schulte Evoline



9SS803 *
L26 x H9
Bachmann power frame module



9SS804
L27 P16 H7,5 (totaleH24)
Mobile lamp



9SS805
ø14 H32
Beluxe lamp



9SS806
L42 P20 H24
Mobile shelf

Stripes

Design **Jérôme Gauthier** 2009

Optionals



9SS807 *
L24 x H7,5
Bachmann power frame module



9SS808
P36 H115
High shelf for sofas



9SS809
P36 H77
Low shelf for sofas

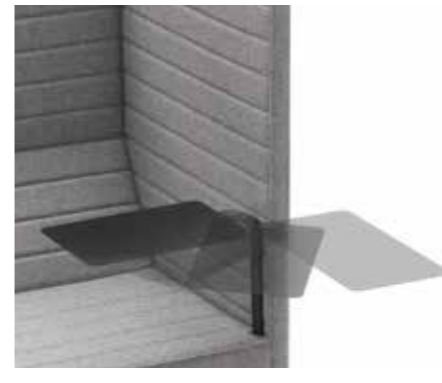

9SS810
L25 P40
Mobile writing shelf

The Bachmann Power Frame electric module is available in the standard version with 2 Schuko and 2 USB sockets, in accordance with the European standards; on demand, it is also available according to the Swiss or European standards or it can be customized with different combinations of internal modules with a price increase.

The standard kit is available with 1 Schuko, 1 USB and 1 RJ45 socket, exclusively according to the European standards.

Stripes

Design Jérôme Gauthier 2009

*Other colours
available on demand*

Tables finishes
HPL samples



0001

0561

0593

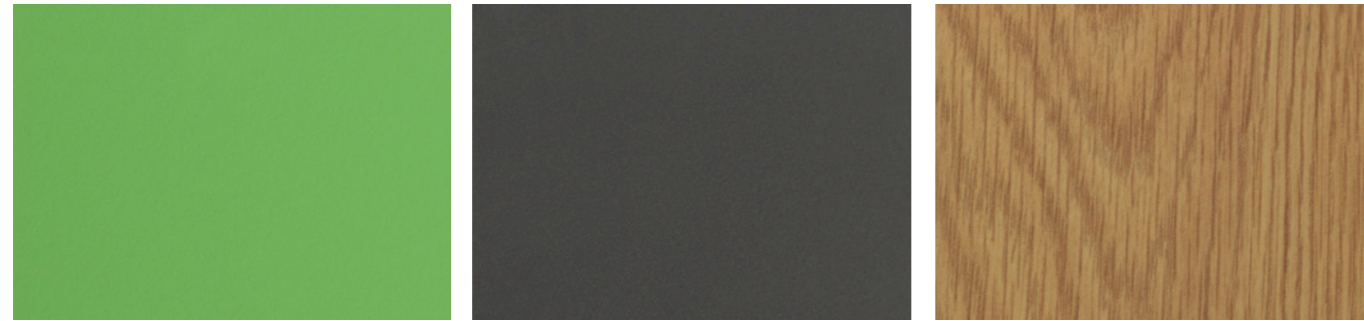

0606

0706

1661



4511

4513

4517



4528

4529

4537

Stripes

Design Jérôme Gauthier 2009

Tables finishes
Oak samples



OPR1
Cherry stained oak

OPR2
Wengé stained oak

OPR3
Walnut stained oak

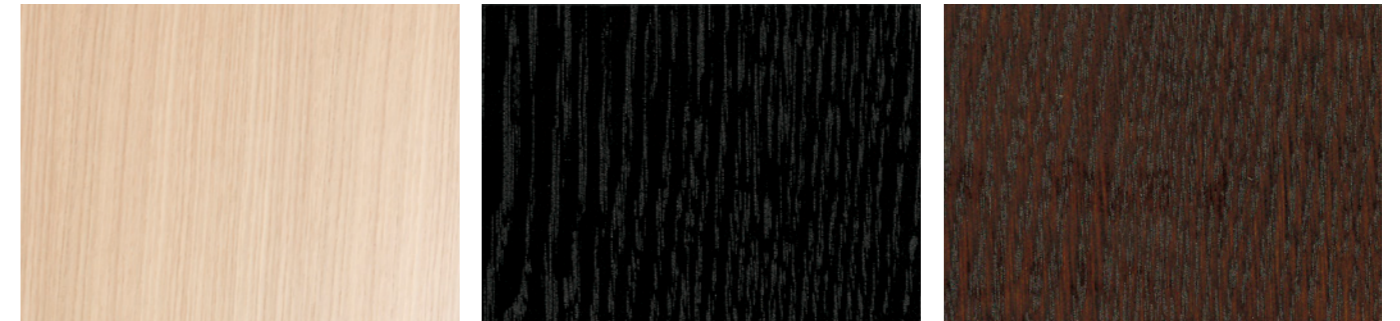

OPR4
Natural oak

OPR5
Black stained oak

OPR6
Cherry Milano stained oak

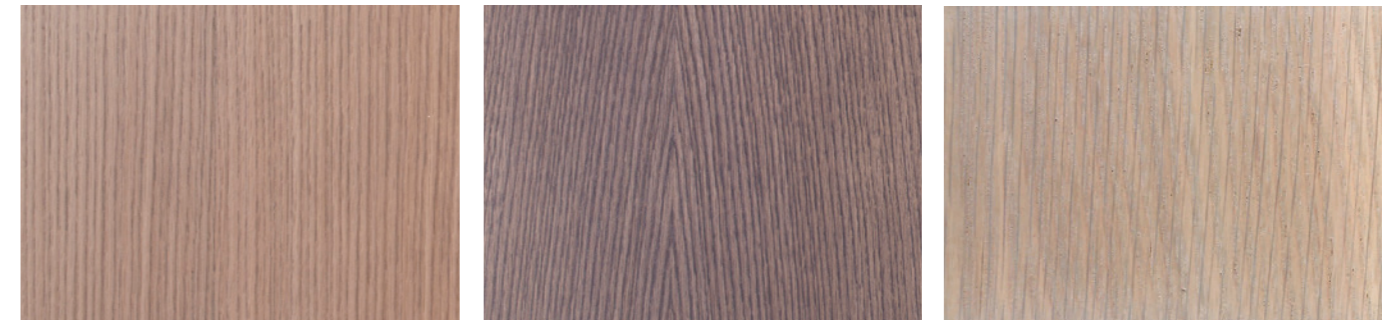

OPR8
Tobacco stained oak

OPR9
Grey taupe stained oak

OPR10
Whitened oak

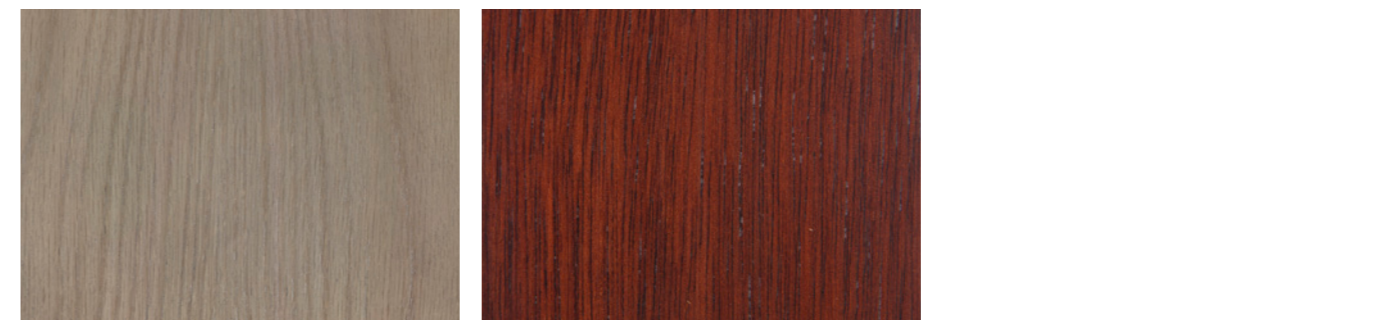

OPR11
Charcoal stained oak

OPR12
Mahogany stained oak

Stripes

Design Jérôme Gauthier 2009

Tables finishes
Melamine samples



Whitened oak

Taupe oak

Tabacco oak

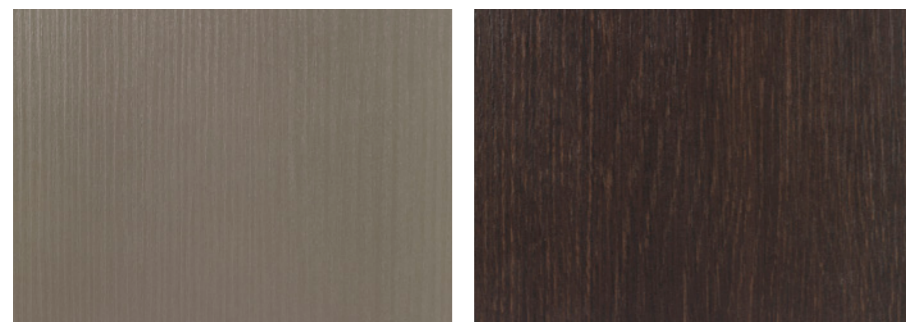

Grey oak

Wengé oak



White

Whitened

Grey

Stripes

Design Jérôme Gauthier 2009

Metal finishes



OPM1
Shiny chrome metal

OPM2
Brushed matt chrome metal

OPM3
Brushed matt dark grey metal



OPM6
RAL 9017 black painted metal

OPM7
RAL 9016 white painted metal

OPM9
Classic bronze painted metal



OPM12
Brushed copper metal

OPM13
Brushed antique brass metal

OPM14
Shiny black chrome metal



OPM15
Brushed antique gold metal

RAL 9006
Aluminium painted metal

Metal painted
in RAL Classic colours

Stripes

Design Jérôme Gauthier 2009

Compositions

COMPOSITION A

Pagg. 10-11-12-13-14-15

9SS604 x4
Sofa
9SS809 x2
Low shelf

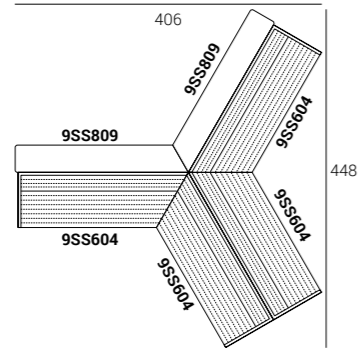

COMPOSITION B

Pagg. 20-21-22-23

9SS908 x2
Sofa
9SS907
Sofa

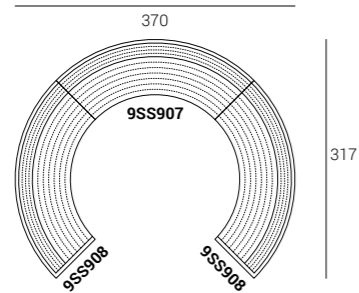

COMPOSITION C with high shelf

Pagg. 24-25-26-27

9SS208 x2
Sofa
9SS808
High shelf
9SS404X
Table

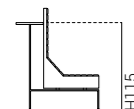
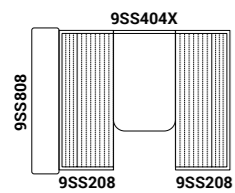

COMPOSITION C with low shelf

Pagg. 24-25-26-27

9SS208 x2
Sofa
9SS809
Low shelf
9SS404X
Table

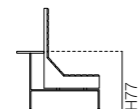
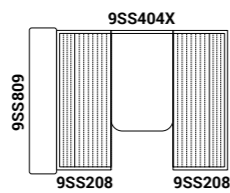

Stripes

Design Jérôme Gauthier 2009

Compositions

COMPOSITION D

Pagg. 32-33-34-35

9SS210 x2
Sofa
9SS809 x2
Low shelf

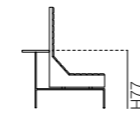
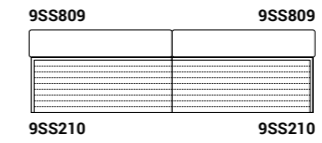

COMPOSITION E

Pagg. 36-37

9SS401 x2
Sofa
9SS405X
Table

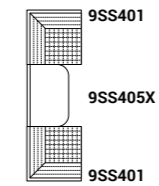

COMPOSITION F

Pagg. 36-37

9SS610 x2
Sofa
9SS808
High shelf

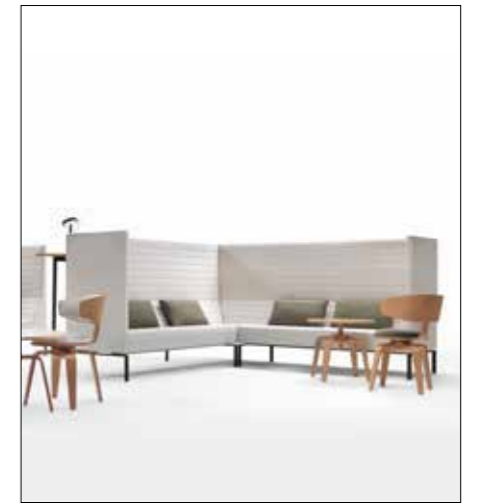
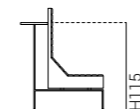
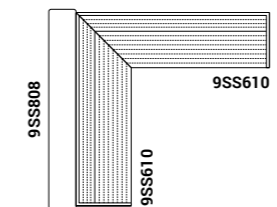

Stripes

Design Jérôme Gauthier 2009

Compositions

COMPOSITION G

Pagg. 42-43

- 9SS401**
Sofa
- 9SS403X**
Table

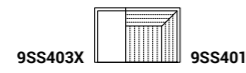

COMPOSITION H

Pagg. 42-43

- 9SS401** x2
Sofa
- 9SS402X**
Table

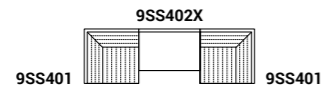

COMPOSITION J

Pagg. 50-51-52-53

- 9SS614** x2
Sofa
- 9SS615** x1
Sofa
- 9SS908** x3
Low shelf

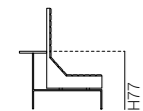
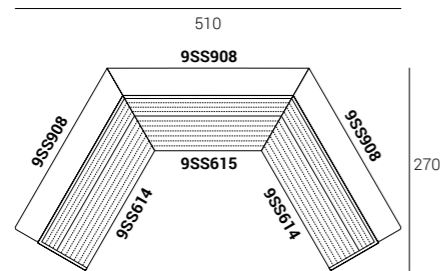

Stripes

Design Jérôme Gauthier 2009

Compositions

COMPOSITION K

Pagg. 54-55-56-57

- 9SS907**
Sofa
- 9SS906**
Sofa
- 9SS909**
Sofa
- 9SS207**
Sofa
- 9SS805**
Low shelf

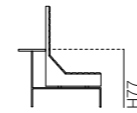
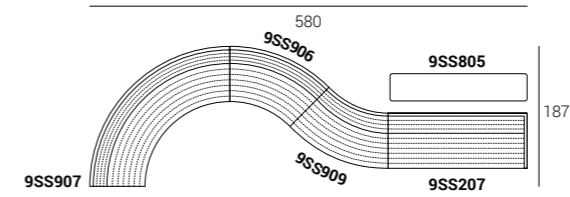

COMPOSITION L

Pagg. 64-65

- 9SS208** x2
Sofa
- 9SS401X**
Table

