

# take off

evolution



# take off

## evolution

## index

take off evolution	2
evo	4
country	30
farm	48
technical	66

# take off

## evolution

### evo

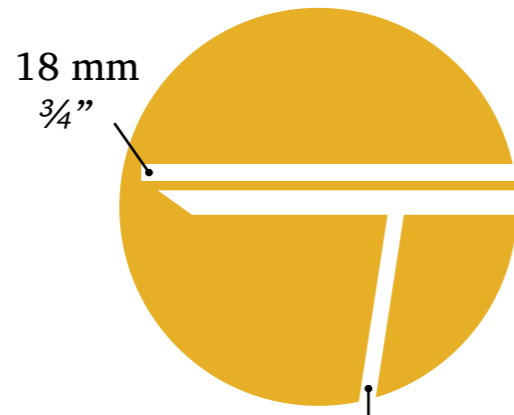

metallo - metal - métal  
metall - metaal - metal

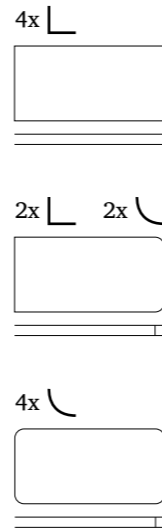

P. 60 / 80 / 100 cm  
P. 23¼" / 31½" / 39¼"

P. 124 / 164 cm  
P. 48¾" / 64½"

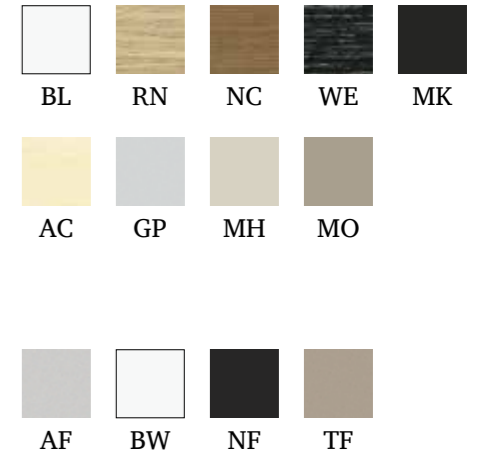
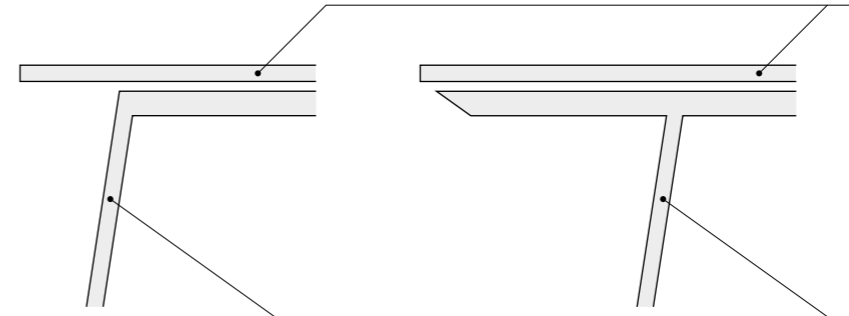

### country

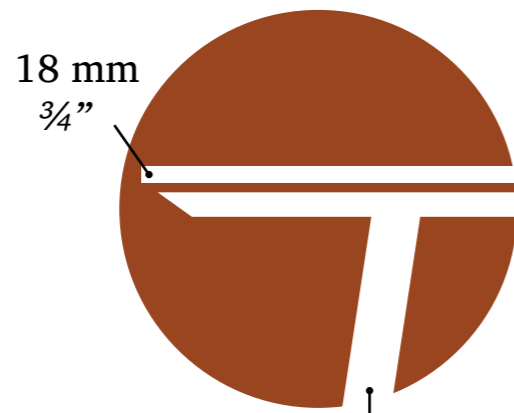
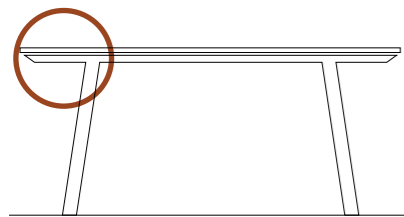

rivestito - coated - revêtu  
beschichtete - bekleed - revestido

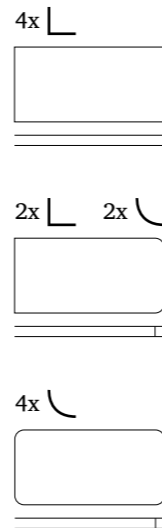

P. 100 / 124 / 164 cm  
P. 39¼" / 48¾" / 64½"

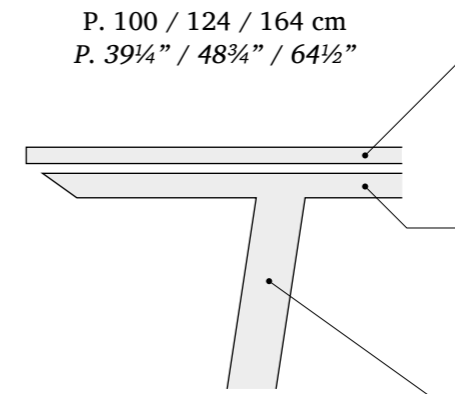

### farm

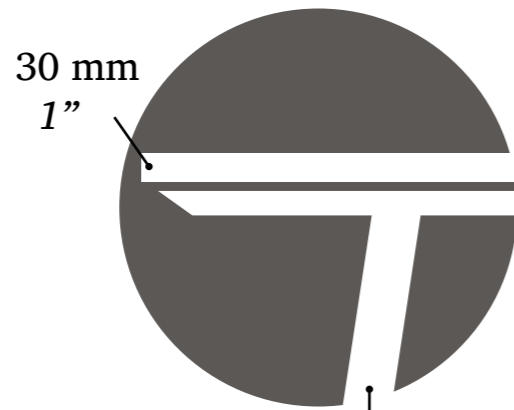
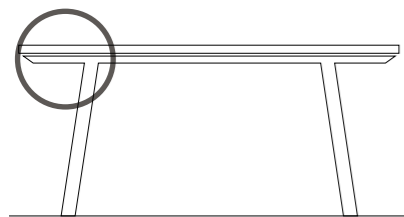

rivestito - coated - revêtu  
beschichtete - bekleed - revestido

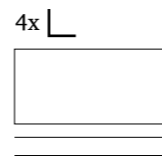

P. 100 / 124 / 164 cm  
P. 39¼" / 48¾" / 64½"

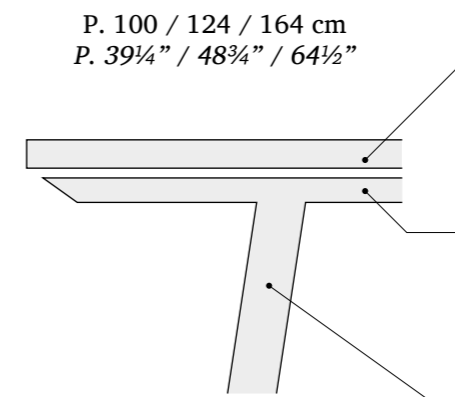

take off  
evolution

evo



# take off

evolution **evo**

**Gambe:** verniciate epox bianco / **Piani + modesty panel:** melaminico wengé / **Fianchi e top armadio + mobile EKO:** melaminico bianco / **Ante armadio:** vetro temperato tortora e melaminico nebbia / **Maniglie:** KR

Beine: Pulverlackiert Weiß / Tischplatten + Knieraumblenden: Melamin Wenge / Seitenverkleidungen und Schrankabdeckungen + Container EKO: Melamin Weiß / Schranktüren: gehärtetes Glas Taubengrau und Melamin Nebelgrau / Griffe KR

Legs: white painted epoxy resin / Tops + modesty panels: wengue melamine wood / Finishing sides and top + EKO cabinet: white melamine wood / Hinged doors: light grey coloured tempered glass and fog coloured melamine / Handles KR

Poten: gelakt epoxy wit / Bladen + knieschotten: wengé melamine / Zijpanelen en top kast + meubel EKO: wit melamine / Deuren kast: duifgrijs kleurig gehard glas en mistkleurig melamine / Handgrepen KR

Pieds : peints époxy blanc / Dessus + voile de fond : mélaminé wengé / Côtés et dessus placard + meuble EKO : mélaminé blanc / Portes armoires : verre trempé tourterelle et mélaminé brouillard / Poignées KR

Patas: barnizadas epoxi blanco / Sobres + faldon: melamina wengué / Costados y techo armario + mueble EKO: melamina blanco / Puertas armario: cristal templado gris ceniciento y melamina niebla / Manillas KR





**Gambe: verniciate epox nero / Piano + modesty panel: melaminico wengé / Fianchi e top armadio + mobile EKO: melaminico nero / Ante armadio: vetro temperato tortora / Maniglie KR**

Beine: Pulverlackiert Schwarz / Tischplatten + Knieraumblenden: Melamin Wenge / Seitenverkleidungen und Schrankabdeckungen + Container EKO: Melamin Schwarz / Schranktüren: gehärtetes Glas Taubengrau / Griffe KR

Legs: black painted epoxy resin / Top + modesty panels: Wenge melamine / Finishing sides and top + EKO cabinet: black melamine / Closet doors: light grey coloured tempered glass / Handles KR

Poten: gelakt epoxy zwart / Blad + knieschotten: wengé melamine / Zijpanelen en top kast + meubel EKO: zwart melamine / Deuren kast: duifgrijs kleurig gehard glas / Handgrepen KR

Pieds : peints époxy noir / Dessus + voile de fond : mélaminé wenge / Côtés et dessus placard + meuble EKO : mélaminé noir / Portes armoires: verre trempé tourterelle / Poignées KR

Patas: barnizadas epoxi negro / Sobre+faldon: melamina wengué / Costados y techo armario + mueble EKO: melamina negra / Puertas armario: cristal templado gris ceniciento / Manillas KR



**Colonna e base verniciate epox alluminio / Piano: melaminico wengé**

Säule und Bodenteller pulverlackiert Aluminium / Tischplatte: Melamin Wenge

Column and base: aluminium painted epoxy resin / Top: wengue melamine wood

Kolom of basis gelakt epoxy aluminium / Blad: wengé melamine

Colonne et base peintes époxy aluminium / Dessus : mélaminé wenge

Columna y base barnizadas epoxi aluminio / Sobre: melamina wengué

**Gambe: verniciate epox bianco / Piano + modesty panel: melaminico wengé / Mobile EKO: melaminico bianco / Maniglie bianche**

Legs: white painted epoxy resin / Top + modesty panels: wengue melamine wood / EKO cabinet: white melamine wood / White handles

Pieds : peints époxy blanc / Dessus + voile de fond : mélaminé wenge / Meuble EKO : mélaminé blanc / Poignées blanches

Beine: Pulverlackiert Weiß / Tischplatten + Knieraumblenden: Melamin Wenge / Container EKO: Melamin Weiß / Weiße Griffe

Poten: gelakt epoxy wit / Blad + knieschotten: wengé melamine / Meubel EKO: wit melamine / Wit handgrepen

Patas: barnizadas epoxi blanco / Sobre +faldon: melamina wengué / Mueble EKO: melamina blanco / Manillas blancas



**Fianchi e top armadio: melaminico bianco / Ante armadio: melaminico tortora / Maniglie KR**

Finishing sides and top: white melamine wood / Closet sides: light grey coloured melamine wood / Handles KR

Côtés et dessus placard : mélaminé blanc / Portes armoires : mélaminé tourterelle / Poignées KR

Seitenverkleidungen und Schrankabdeckungen: Melamin Weiß / Schranktüren: Melamin Taubengrau / Griffe KR

Zijpanelen en top kast: wit melamine / Deuren kast: duifgrijs kleurig melamine / Handgrepen KR

Costados y techo armario: melamina blanca / Puertas armario: melamina gris ceniciento / Manillas KR



# take off

evolution **evo**

**Gambe + porta cpu: verniciate epox bianco / Piani + schermi + cassettiere + vertical file: melaminico bianco / Piano tavolo + ante Ubi: melaminico noce canaletto / Ubi: melaminico bianco / Passacavi tavolo: tessuto Puma - Nero**

Beine + Computerträger: Pulverlackiert Weiß / Tischplatten + Sichtschutz + Container + Vertical File: Melamin Weiß / Tischplatte + Türen Ubi: Melamin Canaletto Nußbaum / Ubi: Melamin Weiß Tisch-Kabel-durchlass: Stoff Puma - Schwarz

Legs + CPU holder: white painted epoxy resin / Tops + panels + drawers + vertical file: white melamine wood / Table top + Ubi doors: Canaletto walnut melamine wood / Ubi: white melamine wood / Table cable holder: Puma - Black fabric

Poten + CPU-houder: gelakt epoxy wit / Bladen + schermen + ladenkasten + hangmappen: wit melamine / Tafelblad + deuren Ubi: notenkleurig melamine geleiding / Ubi: wit melamine / Kabeldoorvoer tafel: stof Poema - Zwart

Pieds + porte-CPU : peints époxy blanc / Dessus + écrans + coissons + classeur vertical : mélaminé blanc / Dessus table + vantaux Ubi : mélaminé noyer canaletto / Ubi : mélaminé blanc / Passe-câbles table : tissu Puma - Noir

Patas + soporte para cpu: barnizadas epoxi blanco / Sobres + pantallas + cajoneras + archivador vertical: melamina blanco / Sobre mesa + puertas Ubi: melamina nogal negro / Ubi: melamina blanco / Pasacables mesa: tejido Puma - Negro





**Gambe: verniciate epox tortora/ Ante e frontali Ubi: melaminico tortora / Ubi: melaminco bianco**

Beine: Pulverlackiert Taubengrau / Türen und Fronten Ubi: Melamin Taubengrau / Ubi: Melamin Weiß

Legs: light grey painted epoxy resin / Ubi doors and front panels: grey melamine wood / Ubi: white melamine wood

Poten: gelakt epoxy duifgrijs / Deuren en voorpanelen Ubi: duifgrijs melamine / Ubi: wit melamine

Pieds : peints époxy tourterelle / Portes et façades Ubi : mélaminé tourterelle / Ubi : mélaminé blanc

Patas: barnizadas epoxi gris ceniciento / Puertas y frentes Ubi: melamina gris ceniciento / Ubi: melamina blanco

**Gambe: verniciate epox bianco / Ubi: melaminico bianco / Piano tavolo + ante Ubi: melaminico rovere naturale / Passacavi tavolo: tessuto Puma - Nero**

Beine: Pulverlackiert weiß / Tischplatte + Türen Ubi: Melamin Eiche natur / Tisch-Kabeldurchlass: Stoff Puma - Schwarz

Legs: white painted epoxy resin / Ubi: white melamine wood / Table top + Ubi doors: Natural oak melamine / Table cable holder: Puma - Black fabric

Poten: gelakt epoxy wit / Ubi: wit melamine / Tafelblad + deuren Ubi: natuurlijk eiken Melamine / Kabeldoorvoer tafel: stof Poema - Zwart

Pieds : peints époxy blanc / Ubi : mélaminé blanc / Dessus table + façades Ubi : mélaminé chêne naturel / Passe-câbles table : tissu Puma - Noir

Patas: barnizadas epoxi blanco / Ubi: melamina blanco / Sobre mesa + puertas Ubi: melamina roble natural / Pasacables mesa: tejido Puma - Negro



**Gambe + porta cpu: verniciate epox bianco / Piani + vertical file: melaminico bianco**

Legs + CPU holder: white painted epoxy resin / Tops + vertical file: white melamine wood

Pieds + porte-CPU : peints époxy blanc / Dessus + classeur vertical : mélaminé blanc

Beine + Computertträger: Pulverlackiert Weiß / Tischplatten + Vertical File: Melamin Weiß

Poten + CPU-houder: gelakt epoxy wit / Bladen + schermen + hangmappen: wit melamine

Patas + soporte para cpu: barnizadas epoxi blanco / Sobres + archivador vertical: melamina blanco





**Alcuni esempi di possibili configurazioni - Some examples of possible layouts - Voici quelques exemples de configurations possibles - Einige Beispiele von möglichen Konfigurationen - Een aantal voorbeelden van mogelijke configuraties - Algunos ejemplos de configuraciones posibles**

**Per una più completa visione della collezione, consultare il listino**  
 Pour un meilleur aperçu de la collection, veuillez consulter la liste des prix  
 Om de volledige collectie te raadplegen, zie de lijst

To view the collection in more detail, Please refer to our price list  
 Eine komplette Ansicht der Kollektion finden Sie in der Preisliste  
 Para ver más detalladamente la colección, consultar la tarifa

10/11 12/13		cm	inch	angle
	<b>Scrivanía con cassetiera portante</b> Desk with drawer unit Bureau avec caisson portant Schreibtisch mit Stützcontainer Bureau met dragende ladenblok Escritorio con cajonera portante	L. 140 ÷ 240 P. 80 H. 72	L. 55" ÷ 94½" P. 31½" H. 28¼"	4x 
• CM.0408.M4				
	<b>Scrivanía con vertical file Sx</b> Desk with left vertical file Bureau avec classeur vertical gauche Schreibtisch mit Vertical File links Bureau met hangmappen links Escritorio con archivadores verticales izquierdo	L. 140 ÷ 240 P. 80 H. 72	L. 55" ÷ 94½" P. 31½" H. 28¼"	4x 
• CM.0408.ES				
	<b>Scrivanía con cassetiera portante</b> Desk with drawer unit Bureau avec caisson portant Schreibtisch mit Stützcontainer Bureau met dragende ladenblok Escritorio con cajonera portante	L. 140 ÷ 240 P. 80 H. 72	L. 55" ÷ 94½" P. 31½" H. 28¼"	2x  2x 
• CM.0408.M3				
	<b>Scrivanía con vertical file Sx e top</b> Desk with left vertical file and top Bureau avec classeur vertical gauche et dessus Schreibtisch mit Vertical File links und Abdeckplatte Bureau met hangmappen links en top Escritorio con archivadores verticales izquierdo y sobre	L. 140 ÷ 280 P. 80 H. 72	L. 55" ÷ 110¼" P. 31½" H. 28¼"	2x  2x 
• CM.1108.ES				
	<b>Scrivanía a ponte su mobile di servizio Eko</b> Bridge desk on service cabinet EKO Bureau pont sur meuble de service EKO Schreibtisch-Brücke auf Stützsideboard EKO Brugtafel op serviceunit EKO Escritorio puente en mueble de servicio EKO	L. 168 ÷ 268 P. 142 H. 72	L. 74" ÷ 105½" P. 56" H. 28¼"	2x  2x 
• BD.1206.C2				
	<b>Scrivanía con gamba zoppa su mobile</b> Desk with half leg on cabinet Bureau avec pied court sur meuble Schreibtisch mit kurzem Fuß auf Stützsideboard Bureau met poot op meubel Escritorio con pata apoyada en mueble	L. 168 ÷ 268 P. 194 H. 72	L. 74" ÷ 105½" P. 76¼" H. 28¼"	2x  2x 
• BD.1206.C2				

10/11 12/13		cm	inch	angle
	<b>Scrivanía con cassetiera portante</b> Desk with drawer unit Bureau avec caisson portant Schreibtisch mit Stützcontainer Bureau met dragende ladenblok Escritorio con cajonera portante	L. 180 ÷ 240 P. 80 H. 72	L. 70¾" ÷ 94½" P. 31½" H. 28¼"	4x 
• CM.0408.M3				
	<b>Scrivanía con vertical file Dx</b> Desk with right vertical file Bureau avec classeur vertical droit Schreibtisch mit Vertical File rechts Bureau met hangmappen rechts Escritorio con archivadores verticales derecho	L. 180 ÷ 240 P. 80 H. 72	L. 70¾" ÷ 94½" P. 31½" H. 28¼"	2x  2x 
• CM.0408.ED				
	<b>Scrivanía con vertical file Sx e top</b> Desk with left vertical file and top Bureau avec classeur vertical gauche et dessus Schreibtisch mit Vertical File links und Abdeckplatte Bureau met hangmappen links en top Escritorio con archivadores verticales izquierdo y sobre	L. 180 ÷ 280 P. 80 H. 72	L. 70¾" ÷ 110¼" P. 31½" H. 28¼"	2x  2x 
• CM.1108.ES				
	<b>Scrivanía a ponte su mobile di servizio Eko</b> Bridge desk on service cabinet EKO Bureau pont sur meuble de service EKO Schreibtisch-Brücke auf Stützsideboard EKO Brugtafel op serviceunit EKO Escritorio puente en mueble de servicio EKO	L. 188 ÷ 268 P. 142 H. 72	L. 74" ÷ 105½" P. 56" H. 28¼"	2x  2x 
• BD.1206.C3				
	<b>Scrivanía con gamba zoppa su mobile</b> Desk with half leg on cabinet Bureau avec pied court sur meuble Schreibtisch mit kurzem Fuß auf Stützsideboard Bureau met poot op meubel Escritorio con pata apoyada en mueble	L. 188 ÷ 268 P. 194 H. 72	L. 74" ÷ 105½" P. 76¼" H. 28¼"	2x  2x 
• BD.1206.C2				
	<b>Scrivanía + dattilo appeso</b> Desk + workwall Bureau + dactylo suspendu Schreibtisch + Andocktisch Bureau + oplegtafel Escritorio + ala escritorio suspendida	L. 140 ÷ 240 P.80 + 120 x 60 H. 72 L. 160 ÷ 240 P.100 + 120 x 60 H. 72	L. 55" ÷ 94½" P. 31½" + 47¼" x 23¾" H. 28¼" L. 63" ÷ 94½" P. 39¼" + 47¼" x 23¾" H. 28¼"	2x  2x 
	<b>Scrivanía + dattilo appeso con cassetiera portante</b> Desk + workwall with drawer unit Bureau + dactylo suspendu avec caisson portant Schreibtisch + Andocktisch mit Stützcontainer Bureau + oplegtafel met dragende ladenblok Escritorio + ala escritorio suspendida con cajonera portante	L. 140 ÷ 240 P.80 + 120 x 60 H. 72 L. 160 ÷ 240 P.100 + 120 x 60 H. 72	L. 55" ÷ 94½" P. 31½" + 47¼" x 23¾" H. 28¼" L. 63" ÷ 94½" P. 39¼" + 47¼" x 23¾" H. 28¼"	2x  2x 
• CM.0407.M4				

# take off

evolution **evo**

**Gambe: verniciate epox bianco / Piani + vertical file + mobile portante + Ubi: melaminico bianco / Schermi: laccato oceano**

Poten: gelakt epox wit / Bladen + vertical files + draagmeubel + Ubi: wit melamine / Schermen: gelakt oceanblauw

Legs: white painted epoxy resin / Tops + vertical file + supporting structure + Ubi: white melamine wood / Panels: ocean blue lacquered wood

Poten: gelakt epoxy wit / Bladen + hangmappen + draagmeubel + Ubi: wit melamine / Schermen: gelakt oceanblauw

Pieds : peints époxy blanc / Dessus + classeur vertical + meuble portant + Ubi : mélaminé blanc / Écrans : laqué océan

Patas: barnizadas epoxi blanco / Sobres + archivador vertical + mueble portante + Ubi: melamina blanco / Pantallas: lacado océano





**Gambe:** verniciate epox bianco / Piani + mobili portanti + Ubi: melaminico bianco / Schermi: tessuto Puma-Bordeaux e laccato verde muschio

Legs: white painted epoxy resin / Tops + supporting structures + Ubi: white melamine wood / Panels: Puma - Burgundy fabric and musk green lacquered wood

Pieds : peints époxy blanc / Dessus + meubles portants + Ubi : mélaminé blanc / Écrans : tissu Puma - Bordeaux et laqué vert mousse

Beine: Pulverlackiert weiß / Tischplatten + Stützsideboard + Ubi: Melamin Weiß / Sichtschutz: Stoff Puma - Bordeaux, lackiert Moosgrün

Poten: gelakt epoxy wit / Bladen + draagmeubels + Ubi: wit melamine / Schermen: stof Poema - Bordeaux, gelakt muskusgroen

Patas: barnizadas epoxi blanco / Sobres + muebles portantes + Ubi: melamina blanco / Pantallas: tejido Puma - Burdeos, / lacado verde musgo



**Gambe + cassettino:** verniciati epox bianco / Piani + mobili portanti + Ubi: melaminico bianco / Schermi: laccato giallo gold

Beine + Schublade: Pulverlackiert weiß / Tischplatten + Stützsideboard + Ubi: Melamin Weiß / Sichtschutz: lackiert Gold-gelb

Legs+ drawer: white painted epoxy resin / Tops + supporting structures + Ubi: white melamine wood / Panels: gold lacquered wood

Poten + lade: gelakt epoxy wit / Bladen + draagmeubels + Ubi: wit melamine / Schermen: gelakt goudgeel

Pieds + tiroir : peints époxy blanc / Dessus + meubles portants + Ubi : mélaminé blanc / Écrans : laqué jaune or

Patas + cajón: barnizadas epoxi blanco / Sobres + muebles portantes + Ubi: melamina blanco / Pantallas: lacado amarillo gold

**Gambe + cassettino:** verniciati epox bianco / Piani + mobili portanti + Ubi: melaminico bianco / Schermi: laccato nebbia

Legs + drawer : white painted epoxy resin / Tops + supporting structures + Ubi: white melamine wood / Panels: fog coloured lacquered wood

Pieds + tiroir: peints époxy blanc / Dessus + meubles portants + Ubi : mélaminé blanc / Écrans : laqué brouillard

Beine + Schublade: Pulverlackiert weiß / Tischplatten + Stützsideboard + Ubi: Melamin Weiß / Sichtschutz: lackiert Nebelgrau

Poten + lade: gelakt epoxy wit / Bladen + draagmeubels + Ubi: wit melamine / Schermen: gelakt mistkleurig

Patas + cajón: barnizadas epoxi blanco / Sobres + muebles portantes + Ubi: melamina blanco / Pantallas: lacado niebla



# take off

evolution **evo**



**Piani: melaminico bianco / Ubi: melaminico bianco /  
Ante Ubi: rovere naturale / Schermi: tessuto Xpress -  
Giallo primavera**

Tops: white melamine wood / Ubi: white melamine wood  
/ Ubi doors: natural oak wood / Panels: Xpress - Spring  
Yellow fabric

Dessus : mélaminé blanc / Ubi : mélaminé blanc /  
façades Ubi : chêne naturel / Écrans : tissu Xpress - Jaune  
printemps

Tischplatten: Melamin Weiß / Ubi: Melamin Weiß /  
Türen Ubi: Eiche natur / Sichtschutz: Stoff Xpress - Früh-  
lingsgelb

Bladen: wit melamine / Ubi: wit melamine / Deuren Ubi:  
natuurlijk eiken / Schermen: stof Xpress - lentegeel







Sobres: melamina blanco / Ubi: melamina blanco /  
Puertas Ubi: roble natural / Pantallas: tejido Xpress - Amari-  
llo primavera

Alcuni esempi di possibili configurazioni - Some examples of possible layouts - Voici quelques exemples de configurations possibles - Einige Beispiele von möglichen Konfigurationen - Een aantal voorbeelden van mogelijke configuraties - Algunos ejemplos de configuraciones posibles

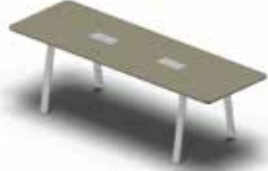
Per una più completa visione della collezione, consultare il listino  
 Pour un meilleur aperçu de la collection, veuillez consulter la liste des prix  
 Om de volledige collectie te raadplegen, zie de lijst

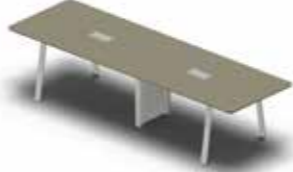
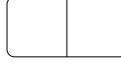
To view the collection in more detail, Please refer to our price list  
 Eine komplette Ansicht der Kollektion finden Sie in der Preisliste  
 Para ver más detalladamente la colección, consultar la tarifa

16/17 18/19		cm	inch	angle
	<b>Tavolino</b> Small table Petit table Kaffeetisch Kleine tafel Mesa	L. 60 P. 60 H. 43	L. 23¾" P. 23¾" H. 17"	 4x ↙
	<b>Tavolino</b> Small table Petit table Kaffeetisch Kleine tafel Mesa	L. 120 P. 60 H. 43	L. 47½" P. 23¾" H. 17"	 4x ↙
	<b>Tavolo con colonna diam.10 e base diam.59</b> Table with diam. 10 column and diam. 59 base Table avec colonne diam.10 et base diam.59 Tisch mit Säule Durchmesser.10 und Bodenplatte Durchmesser.59 Tafel met kolom diam. 10 en voetstuk diam. 59 Mesa con columna diám.10 y base diám.59	L. 100 x 100 P. 120 x 120 H. 72	L. 39¼" x 39¼" P. 47¼" x 47¼" H. 28¼"	 4x ↙
	<b>Tavolo sagomato con colonna e base</b> Shaped table with column and base Table elliptique avec colonne et base Tisch geformt mit Säule und Bodenplatte Gevormde tafel met kolom en basis Mesa ovalada con columna y base	L. 220 P. 124 H. 75	L. 86¾" P. 48¾" H. 29½"	 4x ↙
	<b>Tavolo sagomato con colonna e base e 1 top access</b> Shaped table with column and base and 1 top access Table elliptique avec colonne et base et 1 top access Tisch geformt mit Säule und Bodenplatte und 1 Top Access Gevormde tafel met kolom en basis en 1 toegang Mesa ovalada con columna y base y 1 acceso superior	L. 220 P. 124 H. 75	L. 86¾" P. 48¾" H. 29½"	 4x ↙

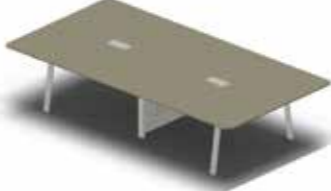
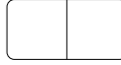
16/17 18/19		cm	inch	angle
	<b>Tavolo con 2 top access</b> Table with 2 top accesses Table avec 2 top access Tisch mit 2 Top Access Tafel met 2 toegangen Mesa con 2 accesos superiores	L. 220 ÷ 240 P. 80 - 100 H. 72	L. 86¾" ÷ 94½" P. 31½" - 39¼" H. 28¼"	 4x ↙
	<b>Tavolo con gamba intermedia con pannello di tamponamento e 2 top access</b> Table middle leg with Infill panel and 2 top accesses Table avec pied intermédiaire avec panneaux de fermeture et 2 top access Tisch mit Zwischenbein, Verkleidungspaneel, 2 Top Access Tafel met tussenpoot met tussenpaneel en 2 toegangen Mesa con pata intermedia con tablero compensación y 2 accesos superiores	L. 320 ÷ 400 P. 100 H. 72	L. 126" ÷ 157½" P. 39¼" H. 28¼"	 4x ↙
	<b>Tavolo</b> Table Table Tisch Tafel Mesa	L. 220 ÷ 280 P. 124 - 164 H. 72	L. 86¾" ÷ 110¼" P. 48¾" - 64½" H. 28¼"	 4x ↙
	<b>Tavolo con 2 top access</b> Table with 2 top accesses Table avec 2 top access Tisch mit 2 Top Access Tafel met 2 toegangen Mesa con 2 accesos superiores	L. 220 ÷ 280 P. 124 - 164 H. 72	L. 86¾" ÷ 110¼" P. 48¾" - 64½" H. 28¼"	 4x ↙
	<b>Tavolo con gamba intermedia con pannello di tamponamento e 2 top access</b> Table middle leg with insulation panel and 2 top accesses Table avec pied intermédiaire avec panneaux de fermeture et 2 top access Tisch mit Zwischenbein, Verkleidungsfassade, 2 Top Access Tafel met tussenpoot met tussenpaneel en 2 toegangen Mesa con pata intermedia con tablero compensación y 2 accesos superiores	L. 320 ÷ 480 P. 124 - 164 H. 72	L. 126" ÷ 189" P. 48¾" - 64½" H. 28¼"	 4x ↙

# take off

evolution **evo**

**Gambe:** verniciate epox bianco / **Piano + ante armadio:** rovere naturale / **Schermo + cassettiere + vertical file:** melaminico bianco

Beine: Pulverlackiert weiß / **Tischplatte + Schranktüren:** Eiche natur / **Sichtschutz + Container + Vertical File:** Melamin Weiß

Legs: white painted epoxy resin / **Top + closet doors:** natural oak wood / **Panel + drawers + vertical file:** white melamine wood

Poten: gelakt epoxy wit / **Blad + deuren kast:** natuurlijk eiken / **Scherm + ladenkasten + hangmappen:** wit melamine

Pieds : peints époxy blanc / **Dessus + Portes armoires:** chêne naturel / **Écran + caissons+ classeur vertical :** mélaminé blanc

Patas: barnizadas epoxi blanco / **Sobre + puertas armarios:** roble natural / **Pantalla + cajoneras + archivador vertical:** melamina blanco



**Alcuni esempi di possibili configurazioni - Some examples of possible layouts - Voici quelques exemples de configurations possibles - Einige Beispiele von möglichen Konfigurationen - Een aantal voorbeelden van mogelijke configuraties - Algunos ejemplos de configuraciones posibles**

**Per una più completa visione della collezione, consultare il listino**  
 Pour un meilleur aperçu de la collection, veuillez consulter la liste des prix  
 Om de volledige collectie te raadplegen, zie de lijst

To view the collection in more detail, Please refer to our price list  
 Eine komplette Ansicht der Kollektion finden Sie in der Preisliste  
 Para ver más detalladamente la colección, consultar la tarifa

24/25 27

		cm	inch	angle
	<b>Bench con 2 vertical File</b> Bench with 2 vertical Files Bench avec 2 classeurs verticaux Bench mit 2 Vertical File Bench met 2 hangmappen Bench con 2 archivadores verticales	L. 180 ÷ 240 P. 164 H. 72	L. 70¾" ÷ 94½" P. 64½" H. 28¼"	 2x  2x 
• CM.0408.ED/ES				
	<b>Bench con 2 UBI con top e 2 vertical File</b> Bench with 2 UBI with top and 2 vertical File Bench avec 2 UBI avec top et 2 classeurs verticaux Bench mit 2 UBI mit Abdeckplatte, 2 Vertical File Bench met 2 ubi met top en 2 hangmappen Bench con 2 UBI con sobre y 2 archivadores verticales	L. 180 ÷ 280 P. 164 H. 72	L. 70¾" ÷ 110¼" P. 64½" H. 28¼"	 2x  2x 
○ UBI UE.8040.00 • CM.0408.ED/ES				
	<b>Bench con 2 cassettiere portanti e mobile con ante scorrevoli</b> Bench with 2 drawer units, 1 sliding door cabinet Bench avec 2 caissons portants et meuble avec portes coulissantes Bench mit 2 Stützcontainern und Sideboard mit Schiebetüren Bench met 2 dragende ladenblokken en meubel met schuifdeuren Bench con 2 cajoneras portante y mueble con puerta corredera	L. 180 ÷ 280 P. 164 H. 72	L. 70¾" ÷ 110¼" P. 64½" H. 28¼"	 2x  2x 
○ CM.0408.M3 • KC.1607.SC				
	<b>Bench con 2 vertical File con top e 1 mobile con ante scorrevoli</b> Bench with 2 vertical Files with top and 1 sliding door cabinet Bench avec 2 classeurs verticaux avec dessus et et 1 meuble avec portes coulissantes Bench mit 2 Vertical File mit Abdeckplatte und 1 Sideboard mit Schiebetüren Bench met 2 hangmappen met top en 1 meubel met schuifdeuren Bench con 2 archivadores verticales con sobre y 1 mueble con puertas correderas	L. 360 ÷ 480 P. 164 H. 72	L. 141¾" ÷ 189" P. 64½" H. 28¼"	 2x  2x 
• KC.1607.SC				
	<b>Bench con 4 cassettiere portanti</b> Bench with 4 drawer units Bench avec 4 caissons portants Bench mit 4 Stützcontainern Bench met 4 dragende ladenblokken Bench con 4 cajoneras portantes	L. 360 ÷ 480 P. 164 H. 72	L. 141¾" ÷ 189" P. 64½" H. 28¼"	 2x  2x 
• CM.0408.M3				
	<b>Bench con 4 UBI con top e 4 vertical File</b> Bench with 4 UBI with top and 4 vertical File Bench avec 4 UBI avec top et 4 classeurs verticaux Bench mit 4 UBI mit Top, 4 Vertical File Bench met 4 ubi met top en 4 hangmappen Bench con 4 UBI con sobre y 4 archivadores verticales	L. 360 ÷ 480 P. 164 H. 72	L. 141¾" ÷ 189" P. 64½" H. 28¼"	 2x  2x 
○ UE.8040.00 • CM.0408.ED/ES				
	<b>Bench con 6 vertical File, Schermo per scrivania</b> Bench with 6 vertical Files, Screen for desk Bench avec 6 classeurs verticaux, Écran privatif pour bureau Bench mit 6 Vertical File, Sichtschutz Bench met 6 hangmappen, Bureauscherm Bench con 6 archivadores verticales, Pantalla para escritorio	L. 540 ÷ 720 P. 164 H. 72	L. 212¾" ÷ 283¾" P. 64½" H. 28¼"	 2x  2x   4x 
• CM.0408.ED/ES				

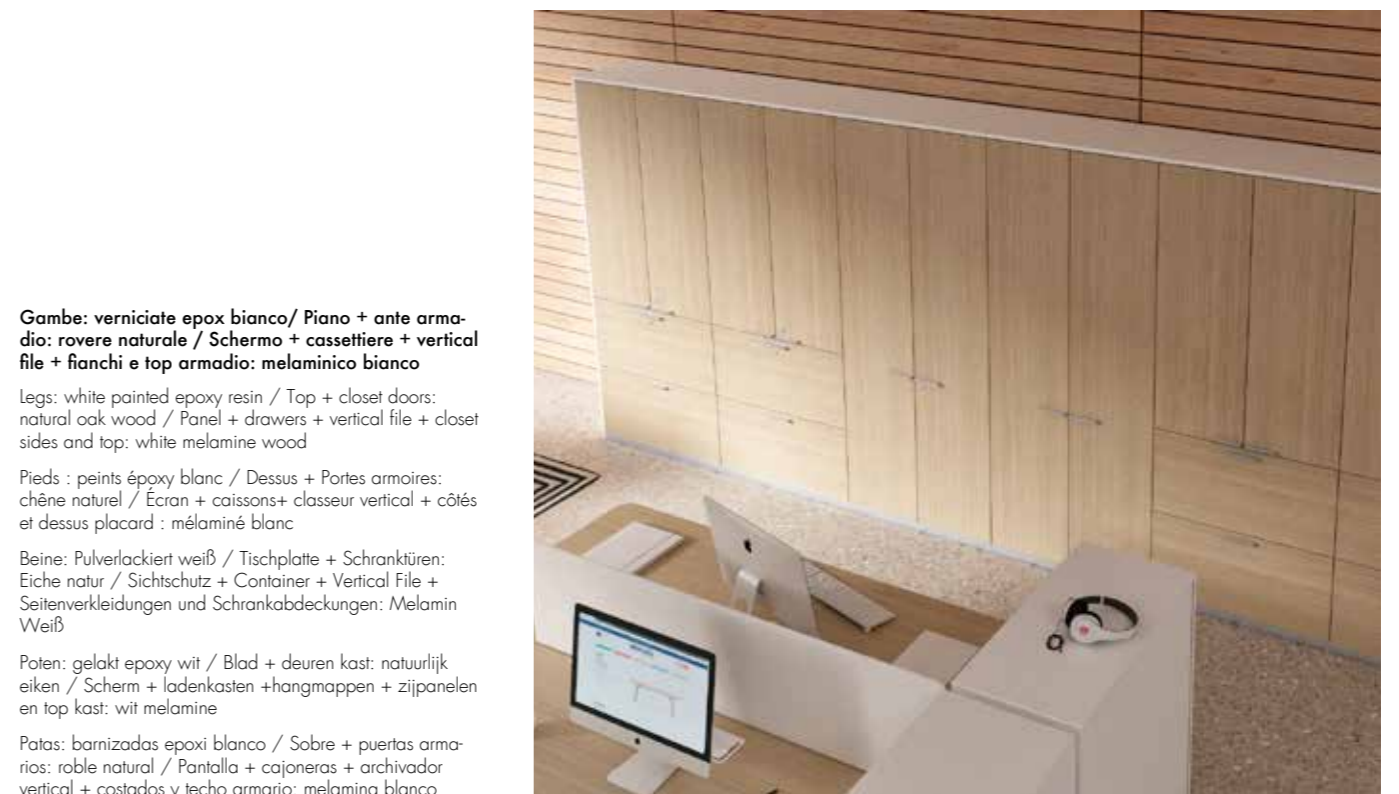

**Gambe: verniciate epox bianco/ Piano + ante armadio: rovere naturale / Schermo + cassettiere + vertical file + fianchi e top armadio: melaminico bianco**

Legs: white painted epoxy resin / Top + closet doors: natural oak wood / Panel + drawers + vertical file + closet sides and top: white melamine wood

Pieds : peints époxy blanc / Dessus + Portes armoires: chêne naturel / Écran + caissons+ classeur vertical + côtés et dessus placard : mélaminé blanc

Beine: Pulverlackiert weiß / Tischplatte + Schranktüren: Eiche natur / Sichtschutz + Container + Vertical File + Seitenverkleidungen und Schrankabdeckungen: Melamin Weiß

Poten: gelakt epoxy wit / Blad + deuren kast: natuurlijk eiken / Scherm + ladenkasten +hangmappen + zijpanelen en top kast: wit melamine

Patas: barnizadas epoxi blanco / Sobre + puertas armarios: roble natural / Pantalla + cajoneras + archivador vertical + costados y techo armario: melamina blanco

Compositions elements & dimensions

06/07 08/09

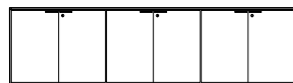

304 x 46 H.83 cm 119<sup>3</sup>/<sub>4</sub>" x 18" H.32<sup>3</sup>/<sub>4</sub>"  
**Armadio mod. A100**  
A100 Cabinet - Armoire A100 - Schränke A100 - Kasten A100 - Armario A100

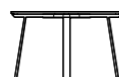

Ø118 H.72 cm Ø46<sup>1</sup>/<sub>2</sub>" H.28<sup>1</sup>/<sub>4</sub>"  
**Tavolo riunione rotondo**  
Round meeting table - Table ronde de réunion - Runder Konferenztisch - Ronde vergadertafel - Mesa redonda de reunión



142 x 56 H.57 cm 56" x 22" H.22<sup>1</sup>/<sub>2</sub>"  
**Mobile di servizio mod. Eko**  
Service Cabinet EKO - Meuble de service - Sideboard EKO - Serviceunit EKO - Mueble de servicio EKO



200 x 80 H.72 cm 78<sup>3</sup>/<sub>4</sub>" x 31<sup>1</sup>/<sub>2</sub>" H.28<sup>3</sup>/<sub>4</sub>"  
**Scrivania**  
Desk - Bureau - Schreibtisch - Bureau - Escritorio  
160 x 1,8 H.38 cm 63" x 3/4" H.15"  
**Modesty panel**  
Modesty panel - Voiles de fond - Knieraumblendenn - Frontpaneel - Panel frontal

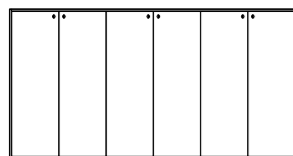

304 x 46 H.160 cm 119<sup>3</sup>/<sub>4</sub>" x 18" H.63"  
**Armadio mod. A100**  
A100 Cabinet - Armoire A100 - Schränke A100 - Kasten A100 - Armario A100



220 x 124 H.75 cm 86<sup>3</sup>/<sub>4</sub>" x 48<sup>3</sup>/<sub>4</sub>" H.29<sup>1</sup>/<sub>2</sub>"  
**Tavolo sagomato con colonna base**  
Shaped table with column and base - Table elliptique avec colonne et base - Tisch geformt mit Säule und Bodenplatte - Gevormde tafel met kolom en basis - Mesa ovalada con columna y base

10/11 12/13

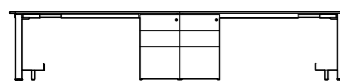

180 x 80 H.72 cm 70<sup>3</sup>/<sub>4</sub>" x 31<sup>1</sup>/<sub>2</sub>" H.28<sup>1</sup>/<sub>4</sub>"  
**N.02 scrivanie con cassetiere portante**  
N.02 Desks with support pedestal - N.02 Bureaux avec caisson portant - N.02 Schreibtische mit Container - N.02 Bureaus met ladenblok - N.02 Escritorios con cajonera de sustentación

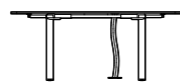

180 x 164 H.72 cm 70<sup>3</sup>/<sub>4</sub>" x 64<sup>1</sup>/<sub>2</sub>" H.28<sup>1</sup>/<sub>4</sub>"  
**Tavolo riunione**  
Meeting table - Table de réunion - Konferenztisch - Vergadertafel - Mesa de reunión



240x40 H.103 cm 94<sup>1</sup>/<sub>2</sub>" x 15<sup>3</sup>/<sub>4</sub>" H.40<sup>1</sup>/<sub>2</sub>"  
**Contentori mod. UBI EVO**  
UBI EVO Containers - Cubes UBI EVO - Container UBI EVO - Containers UBI EVO - Contenedores UBI EVO

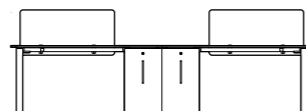

160 x 80 H.72 cm 63" x 31<sup>1</sup>/<sub>2</sub>" H.28<sup>1</sup>/<sub>4</sub>"  
**N.02 Scrivanie con Vertical file basso**  
N.02 Desks with Vertical file - N.02 Bureaux avec classeur vertical - N.02 Schreibtische mit Vertical File - N.02 Bureaus met hangmappen - N.02 Escritorios con Vertical file  
100 x 1,8 H.48 cm 39<sup>1</sup>/<sub>4</sub>" x 3/4" H.18<sup>3</sup>/<sub>4</sub>"  
**Schermo divisorio**  
High screen - Écran haut - Hoher Sichtschutz - Hoog scherm - Pantalla alta

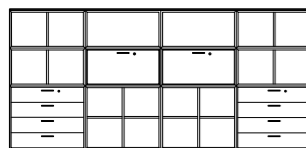

320x40 H.151 cm 126" x 15<sup>3</sup>/<sub>4</sub>" H.59<sup>1</sup>/<sub>2</sub>"  
**Contentori mod. UBI EVO**  
UBI EVO Containers - Cubes UBI EVO - Container UBI EVO - Containers UBI EVO - Contenedores UBI EVO

Per una più completa visione della collezione, consultare il listino  
Pour une vue plus complète de la collection, voir la liste des prix  
Voor een compleet overzicht van de collectie, zie de prijslijst

For a more complete view of the collection, see the price list  
Für eine vollständigere Ansicht der Sammlung finden Sie in der Preisliste  
Para una visión más completa de la colección, consulte la lista de precios

16/17 18/19 20/21

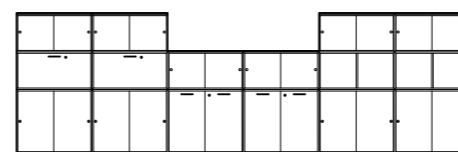

482 x 40 H.151 cm 189<sup>3</sup>/<sub>4</sub>" x 15<sup>3</sup>/<sub>4</sub>" H.59<sup>1</sup>/<sub>2</sub>"  
**Contentori mod. UBI EVO**  
UBI EVO Containers - Cubes UBI EVO - Container UBI EVO - Containers UBI EVO - Contenedores UBI EVO

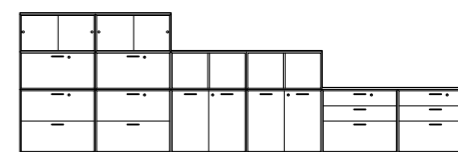

482 x 40 H.151 cm 189<sup>3</sup>/<sub>4</sub>" x 15<sup>3</sup>/<sub>4</sub>" H.59<sup>1</sup>/<sub>2</sub>"  
**Contentori mod. UBI EVO**  
UBI EVO Containers - Cubes UBI EVO - Container UBI EVO - Containers UBI EVO - Contenedores UBI EVO

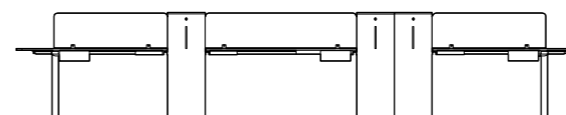

600 x 164 H.73/110 cm 236<sup>1</sup>/<sub>4</sub>" x 64<sup>1</sup>/<sub>2</sub>" H.28<sup>3</sup>/<sub>4</sub>"/43<sup>1</sup>/<sub>4</sub>"  
**Composizione Bench**  
Bench composition - Poste de travail - Bench-Arbeitsplatz - Samenstelling bench - Composición bench

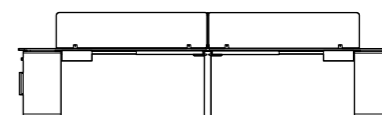

400 x 164 H.72 cm 157<sup>1</sup>/<sub>2</sub>" x 64<sup>1</sup>/<sub>2</sub>" H.28<sup>3</sup>/<sub>4</sub>"  
**Composizione Bench**  
Bench composition - Poste de travail - Bench-Arbeitsplatz - Samenstelling bench - Composición bench

120/160 x 1,8 H.38 cm 47<sup>1</sup>/<sub>4</sub>"/63" x 3/4" H.15"

**Schermo divisorio**  
High screen - Écran haut - Hoher Sichtschutz - Hoog scherm - Pantalla alta

160 x 1,8 H.38 cm 63" x 3/4" H.15"

**Schermo divisorio**  
High screen - Écran haut - Hoher Sichtschutz - Hoog scherm - Pantalla alta  
160 x 40 H.69 cm 63" x 15<sup>3</sup>/<sub>4</sub>" H.27"

**Mobile con ante scorrevoli**  
Cabinet with sliding doors - Meuble avec portes coulissantes - Möbel mit Schiebetüren - Meubel met schuifdeuren - Mueble con puertas correderas



321 x 40 H.111 cm 126<sup>1</sup>/<sub>4</sub>" x 15<sup>3</sup>/<sub>4</sub>" H.43<sup>3</sup>/<sub>4</sub>"  
**Contentori mod. UBI EVO**  
UBI EVO Containers - Cubes UBI EVO - Container UBI EVO - Containers UBI EVO - Contenedores UBI EVO

24/25 27

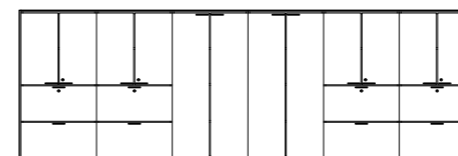

484 x 46 H.160 cm 190<sup>1</sup>/<sub>2</sub>" x 18" H.63"  
**Armadio mod. A100**  
A100 Cabinet - Armoire A100 - Schränke A100 - Kasten A100 - Armario A100

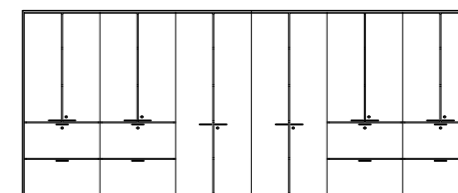

484 x 46 H.198 cm 190<sup>1</sup>/<sub>2</sub>" x 18" H.78"  
**Armadio mod. A100**  
A100 Cabinet - Armoire A100 - Schränke A100 - Kasten A100 - Armario A100

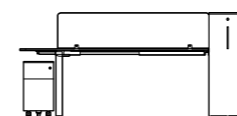

240 x 164 H.72/110 cm 94<sup>1</sup>/<sub>2</sub>" x 64<sup>1</sup>/<sub>2</sub>" H.28<sup>3</sup>/<sub>4</sub>"/43<sup>1</sup>/<sub>4</sub>"  
**Composizione Bench**  
Bench composition - Poste de travail - Bench-Arbeitsplatz - Samenstelling bench - Composición bench

140 x 1,8 H.38 cm 55<sup>1</sup>/<sub>4</sub>" x 3/4" H.15"

**Schermo divisorio**  
High screen - Écran haut - Hoher Sichtschutz - Hoog scherm - Pantalla alta



take off  
evolution

country



# take off evolution country



**Rivestimento gambe + frontali e top cassettiere: melaminico rovere antico / Piani + Ubi: melaminico bianco / Schermi: a sinistra tessuto Xpress - Blue jeans, sopra tessuto Lucia - Blu Martinique**

Leg coating + drawer front panels and tops: decapé oak melamine wood / Tops + Ubi: white melamine wood / Panels: left Xpress - Blue Jeans fabric, above Lucia - Blue Martinique fabric

Revêtement pieds + façades et dessus caissons: mélaminé chêne antique / Plateaux + Ubi : mélaminé blanc / Écrans : gauche revêtement tissu Xpress - Blue jeans, revêtement tissu Lucia - Bleu Martinique

Beinverkleidung + Fronten und Containerabdeckung: Melamin Eiche antik / Tischplatten + Ubi: Melamin Weiß / Sichtschutz: links Stoff Xpress - Blue Jeans, oben Stoff Lucia - Blu Martinique

Bekleding poten + voorpanelen en top ladekasten: verouderd eiken melamine / Bladen + Ubi: wit melamine / Schermen: links stof Xpress - Blue jeans, boven stof Lucia - blauw Martinique











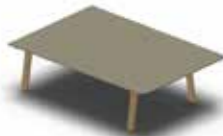

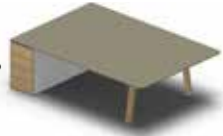

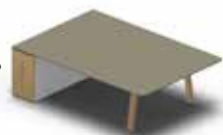

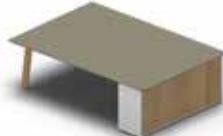

Revestimiento patas + frentes y encimeras cajoneras: melamina roble vintage / Sobres + Ubi: melamina blanco / Pantallas: izquierda tejido Xpress - Blue jeans, encima tejido Lucia - Blu Martinique

**Alcuni esempi di possibili configurazioni - Some examples of possible layouts - Voici quelques exemples de configurations possibles - Einige Beispiele von möglichen Konfigurationen - Een aantal voorbeelden van mogelijke configuraties - Algunos ejemplos de configuraciones posibles**

**Per una più completa visione della collezione, consultare il listino**  
 Pour un meilleur aperçu de la collection, veuillez consulter la liste des prix  
 Om de volledige collectie te raadplegen, zie de lijst

To view the collection in more detail, Please refer to our price list  
 Eine komplette Ansicht der Kollektion finden Sie in der Preisliste  
 Para ver más detalladamente la colección, consultar la tarifa

32/33 35

		cm	inch	angle
	<b>Bench con gambe rivestite</b> Bench with coated legs Bench avec pieds revêtus Bench mit verkleideten Beinen Bench met beklede poten Bench con patas revestidas	L. 160 ÷ 240 P. 164 H. 72	L. 63" ÷ 94½" P. 64½" H. 28¼"	2x  2x 
	<b>Bench con gambe rivestite con 2 cassetiere portanti</b> Bench with coated legs with 2 drawer units Bench avec pieds revêtus avec 2 caissons portants Bench mit verkleideten Beinen mit 2 Stützcontainern Bench met beklede poten met 2 dragende ladenblokken Bench con patas revestidas con 2 cajoneras portantes	L. 180 ÷ 240 P. 164 H. 72	L. 70¾" ÷ 94½" P. 64½" H. 28¼"	2x  2x 
	<b>Bench con gambe rivestite con 2 vertical File</b> Bench with coated legs with 2 vertical Files Bench avec pieds revêtus avec 2 classeurs verticaux Bench mit verkleideten Beinen mit 2 Vertical File Bench met beklede poten met 2 hangmappen Bench con patas revestidas con 2 archivadores verticales	L. 180 ÷ 240 P. 164 H. 72	L. 70¾" ÷ 94½" P. 64½" H. 28¼"	2x  2x 
	<b>Bench con gambe rivestite e 1 mobile con ante scorrevoli</b> Bench with coated legs and 1 sliding door cabinet Bench avec pieds revêtus et 1 meuble avec vantaux coulissants Bench mit verkleideten Beinen und 1 Möbel mit Schiebetüren Bench met beklede poten en 1 meubel met schuifdeuren Bench con patas revestidas y 1 mueble con puertas correderas	L. 160 ÷ 240 P. 164 H. 72	L. 63" ÷ 94½" P. 64½" H. 28¼"	2x  2x 
	<b>Bench con gambe rivestite con gamba intermedia con pannello di tamponamento, Schermo per scrivania</b> Bench with coated legs with middle leg with Infill panel, Screen for desk Bench avec pieds revêtus avec pied intermédiaire avec panneaux de fermeture, Ecran privatif pour bureau Bench mit verkleideten Beinen mit Zwischenbein, Verkleidungspaneel, Sichtschutz Bench met beklede poten met tussenpoot met tussenpaneel, Bureauscherm Bench con patas revestidas con pata intermedia con tablero compensación, Pantalla para escritorio	L. 540 ÷ 720 P. 164 H. 72	L. 212¾" ÷ 283¾" P. 64½" H. 28¼"	2x  2x  4x 
	<b>Bench con gambe rivestite con 6 cassetiere portanti, Schermo per scrivania</b> Bench with coated legs with 6 drawer units, Screen for desk Bench avec pieds revêtus avec 6 caissons portants, Ecran privatif pour bureau Bench mit verkleideten Beinen mit 6 Stützcontainern, Sichtschutz Bench met beklede poten met 6 ladenblokken, Bureauscherm Bench con patas revestidas con 6 cajoneras portantes, Pantalla para escritorio	L. 540 ÷ 720 P. 164 H. 72	L. 212¾" ÷ 283¾" P. 64½" H. 28¼"	2x  2x  4x 
	<b>Bench con gambe rivestite e 2 mobili con ante scorrevoli, Schermo per scrivania</b> Bench with coated legs and 2 sliding door cabinet, Screen for desk Bench avec pieds revêtus et 2 meuble avec vantaux coulissants, Ecran privatif pour bureau Bench mit verkleideten Beinen und 2 Sideboards mit Schiebetüren, Sichtschutz Bench met beklede poten en 2 meubel met schuifdeuren, Bureauscherm Bench con patas revestidas y 2 mueble con puertas correderas, Pantalla para escritorio	L. 540 ÷ 720 P. 164 H. 72	L. 212¾" ÷ 283¾" P. 64½" H. 28¼"	2x  2x 



**Rivestimento gambe + frontali vertical file: melaminico rovere antico / Piani + Ubi: melaminico bianco / Schermi: sopra tessuto Xpress - Verde sottobosco, a destra tessuto Lucia - Petrolio Windjammer**

Legs + vertical file front panels and tops: rustic oak melamine wood / Tops: white melamine wood / Panels: above Xpress - Green Underbush fabric, right Lucia - Petroleum Windjammer fabric

Pieds + façades classeur vertical : mélaminé chêne antique / Plateau : mélaminé blanc / Écrans : revêtement tissu Xpress - Vert sous-bois, droite tissu Lucia - Pétrole-Windjammer

Beine + Fronten Vertical File: Melamin Eiche antik / Tischplatten: Melamin Weiß / Sichtschutz: oben Stoff Xpress - Unterholz-Grün, rechts Stoff Lucia - Petroleum Blau Windjammer

Poten + voorpanelen hangmappen: verouderd eiken melamine / Bladen: wit melamine / Schermen: boven stof Xpress - bosgrondgroen, rechts stof Lucia - Petroleum Windjammer

Patas + frentes archivador vertical: melamina roble vintage / Sobres: melamina blanco / Pantallas: encima tejido Xpress - Verde sotobosque, derecho tejido Lucia - Petróleo-Windjammer



# take off

evolution **country**

**Rivestimento gambe: melaminico rovere anticato /  
Porta cpu: verniciato epox nero / Piani + Ubi: melami-  
nico bianco / Mobili EKO + frontali Ubi: melaminico  
nebbia / Schermo: laccato tortora**

Beineverkleidung: Melamin Eiche Antik / CPU Halter:  
EPOX-lackiert Schwarz / Tischplatten: Melamin Weiß  
/ Möbel EKO + Fassaden Ubi: Melamin Nebelgrau /  
Schirmwand: lackiert Taubengrau / Ubi: Melamin Weiß

Leg coating: decapé oak melamine wood / CPU holder:  
black painted epoxy resin / Tops: white melamine wood  
/ EKO furniture + Ubi front panels: fog coloured melamine  
wood / Panel: light grey lacquered wood / Ubi: white  
melamine wood

Bekleding poten: verouderd eiken melamine / CPU-hou-  
der: gelakt epoxy zwart / Bladen: wit melamine /  
Meubels EKO + voorpanelen Ubi: mistkleurig melamine /  
Scherm: gelakt duifgrijs / Ubi: wit melamine

Revêtement pieds : mélaminé chêne antique / Porte-CPU :  
peint époxy noir / Dessus : mélaminé blanc / Meubles  
EKO + façades Ubi : mélaminé brouillard / Écran : laqué  
tourterelle / Ubi : mélaminé blanc

Revestimiento patas: melamina roble vintage / Soporte  
para cpu: barnizado epoxi negro / Sobres: melamina  
blanco / Muebles EKO + frentes Ubi: melamina niebla /  
Pantalla: lacado gris ceniciento / Ubi: melamina blanco



# take off

evolution **country**



**Rivestimento gambe:** melaminico rovere anticato / **Piani:** melaminico bianco e melaminico nebbia / **Porta cpu:** verniciato epox nero / **Mobili EKO:** melaminico nebbia / **Ubi:** melaminico bianco / **Frontali e ante Ubi:** melaminico nebbia

Leg coating: Clad oak melamine wood / Top: white melamine wood and fog coloured melamine wood / CPU holder: black painted epoxy resin / EKO furniture: fog coloured melamine wood / Ubi: white melamine wood / Ubi front panels and doors: fog coloured melamine wood

Revêtement pieds : mélaminé chêne antique / Dessus : mélaminé blanc et mélaminé brouillard / Porte-CPU : peint époxy noir / Meubles EKO : mélaminé brouillard / Ubi : mélaminé blanc / Façades Ubi : mélaminé brouillard

Beinverkleidung: Melamin Eiche antik / Tischplatte: Melamin Weiß, Melamin Nebelgrau / Computerträger: Pulverlackiert Schwarz / Sideboard EKO: Melamin Nebelgrau / Ubi: Melamin Weiß / Fronten und Türen Ubi: Melamin Nebelgrau

Bekleding poten: verouderd eiken melamine / Blad: wit melamine, mistkleurig melamine / CPU-houder: gelakt epoxy zwart / Meubels EKO: mistkleurig melamine / Ubi: wit melamine / Voorpanelen en deuren Ubi: mistkleurig melamine

Revestimiento patas: melamina roble vintage / Sobre: melamina blanco, melamina niebla / Soporte para cpu: barnizado epoxi negro / Muebles EKO: melamina niebla / Ubi: melamina blanco / Frentes y puertas Ubi: melamina niebla

**Alcuni esempi di possibili configurazioni - Some examples of possible layouts - Voici quelques exemples de configurations possibles - Einige Beispiele von möglichen Konfigurationen - Een aantal voorbeelden van mogelijke configuraties - Algunos ejemplos de configuraciones posibles**

**Per una più completa visione della collezione, consultare il listino**  
 Pour un meilleur aperçu de la collection, veuillez consulter la liste des prix  
 Om de volledige collectie te raadplegen, zie de lijst

To view the collection in more detail, Please refer to our price list  
 Eine komplette Ansicht der Kollektion finden Sie in der Preisliste  
 Para ver más detalladamente la colección, consultar la tarifa

36/37 38/39 41

	cm	inch	angle
	L. 160÷240 P. 100 H. 72	L. 63" ÷ 94½" P. 39¼" H. 28¼"	4x 
	L. 160÷240 P. 100 H. 72	L. 63" ÷ 94½" P. 39¼" H. 28¼"	2x  2x 
	L. 160÷240 P. 100 H. 72	L. 63" ÷ 94½" P. 39¼" H. 28¼"	2x  2x 
	L. 160÷240 P. 100 H. 72	L. 63" ÷ 94½" P. 39¼" H. 28¼"	4x 
	L. 160÷240 P. 100 H. 72	L. 63" ÷ 94½" P. 39¼" H. 28¼"	4x 
	L. 160÷240 P. 100 H. 72	L. 63" ÷ 94½" P. 39¼" H. 28¼"	4x 
	L. 160÷240 P. 100 H. 72	L. 63" ÷ 94½" P. 39¼" H. 28¼"	4x 



**Rivestimento gambe: melaminico rovere antico / Porta cpu: verniciato epox nero / Piani + mobile EKO: melaminico nero / Ante Ubi : melaminico nebbia / Frontale vertical file+ schermo: melaminico tortora**

Beinverkleidung: Melamin Eiche antik / Tischplatten + Sideboard EKO: Melamin Schwarz / Türen Ubi + Front Vertical File: Melamin Taubengrau / Sichtschutz: lackiert Taubengrau

Leg coating: decapé oak melamine wood / CPU holder: black painted epoxy resin / Tops + EKO cabinet: black melamine wood / Ubi doors: fog coloured melamine wood / vertical file front panel + panel: light grey melamine wood

Bekleding poten: verouderd eiken melamine / CPU-houder: gelakt epoxy zwart / Bladen + meubel EKO: zwart melamine / Deuren Ubi: mistkleurig melamine / Voorpaneel hangmappen + Scherm : duifgrijs melamine

Revêtement pieds : mélaminé chêne antique / Porte-CPU : peint époxy noir / Dessus + meuble EKO : mélamine noir / Façades Ubi : melamine brouillard / Façades classeur vertical + Écran : mélaminé tourterelle

Revestimiento patas : melamina roble vintage / Soporte para cpu: barnizado epoxi negro / Sobres + mueble EKO: melamina negro / Puertas Ubi : melamina niebla / Frente archivador vertical + pantalla: melamina gris ceniciento



**Rivestimento gambe: melaminico rovere antico / Piano: melaminico bianco / Mobili EKO: melaminico nebbia / Schermo: tessuto Lucia - Sabbia Aruba**

Leg coating: decapé oak melamine wood / Top: white melamine wood / EKO furniture: fog coloured melamine wood / Panel: Lucia - Aruba Sand fabric

Revêtement pieds : mélaminé chêne antique / Dessus : melamine blanc / Meubles EKO: melamine brouillard / Écran : tissu Lucia - Sable Aruba

Beinverkleidung : Melamin Eiche antik / Tischplatte: Melamin Weiß / Sideboard EKO: Melamin Nebelgrau / Sichtschutz: Stoff Lucia - Sandfarbe Aruba

Bekleding poten: verouderd eiken melamine / Blad: wit melamine / Meubels EKO mistkleurig melamine / Scherm: stof Lucia - Zand Aruba

Revestimiento patas: melamina roble vintage / Sobre: melamina blanco / Muebles EKO: melamina niebla / Pantalla: tejido Lucia - Arena Aruba

# take off evolution **country**

Rivestimento gambe: melaminico rovere antico /  
Piano: melaminico bianco

Beinverkleidung: Melamin Eiche antik / Tischplatte:  
Melamin Weiß

Leg coating: decapé oak melamine wood / Top: white  
melamine wood

Bekleding poten: verouderd eiken melamine / Blad: wit  
melamine

Revêtement pieds : mélaminé chêne antique / Plateau :  
mélaminé blanc

Revestimiento patas: melamina roble vintage / Sobre:  
melamina blanco





















# take off evolution country

Alcuni esempi di possibili configurazioni - Some examples of possible layouts - Voici quelques exemples de configurations possibles - Einige Beispiele von möglichen Konfigurationen - Een aantal voorbeelden van mogelijke configuraties - Algunos ejemplos de configuraciones posibles

Per una più completa visione della collezione, consultare il listino  
Pour un meilleur aperçu de la collection, veuillez consulter la liste des prix  
Om de volledige collectie te raadplegen, zie de lijst

To view the collection in more detail, Please refer to our price list  
Eine komplette Ansicht der Kollektion finden Sie in der Preisliste  
Para ver más detalladamente la colección, consultar la tarifa

		cm	inch	angle
	<b>Tavolino con gambe rivestite</b> Small table with coated legs Petite table avec pieds revêtus Kleiner Tisch mit verkleideten Beinen Tafeltje met beklede poten Mesita con patas revestidas	L. 60 P. 60 H. 43	L. 23¾" P. 23¾" H. 17"	 4x 
	<b>Tavolino con gambe rivestite</b> Small table with coated legs Petite table avec pieds revêtus Kleiner Tisch mit verkleideten Beinen Tafeltje met beklede poten Mesita con patas revestidas	L. 120 P. 60 H. 43	L. 47¼" P. 23¾" H. 17"	 4x 
	<b>Tavolo con gambe rivestite con 1 top access</b> Table with coated legs with 1 top access Table avec pieds revêtus avec 1 top access Tisch mit verkleideten Beinen mit 1 Top Access Tafel met beklede poten met 1 toegang Mesita con patas revestidas con 1 acceso superior	L. 180 ÷ 200 P. 100 H. 72	L. 70¾" ÷ 78¾" P. 39¼" H. 28¼"	 4x 
	<b>Tavolo con gambe rivestite con 2 top access</b> Table with coated legs with 2 top accesses Table avec pieds revêtus avec 2 tops access Tisch mit verkleideten Beinen mit 2 Top Access Tafel met beklede poten met 2 toegangen Mesita con patas revestidas con 2 accesos superiores	L. 220 ÷ 240 P. 100 H. 72	L. 86¾" ÷ 94½" P. 39¼" H. 28¼"	 4x 
	<b>Tavolo con gambe rivestite con 1 top access</b> Table with coated legs with 1 top access Table avec pieds revêtus avec 1 top access Tisch mit verkleideten Beinen mit 1 Top Access Tafel met beklede poten met 1 toegang Mesita con patas revestidas con 1 acceso superior	L. 180 ÷ 200 P. 124 - 164 H. 72	L. 70¾" ÷ 78¾" P. 48¾" - 64½" H. 28¼"	 4x 
	<b>Tavolo con gambe rivestite con gamba intermedia con pannello di tamponamento e top access</b> Table with Clad legs middle leg with infill panel and top access Table avec pieds revêtus avec pied intermédiaire avec panneaux de fermeture et top access Tisch mit verkleideten Beinen mit Zwischenbein, Verkleidungspaneel, Top Access Tafel met beklede poten met tussenpoot met tussenpaneel en toegang Mesita con patas revestidas con pata intermedia con tablero compensación y acceso superior	L. 320 ÷ 480 P. 124 - 164 H. 72	L. 126" ÷ 189" P. 48¾" - 64½" H. 28¼"	 4x 

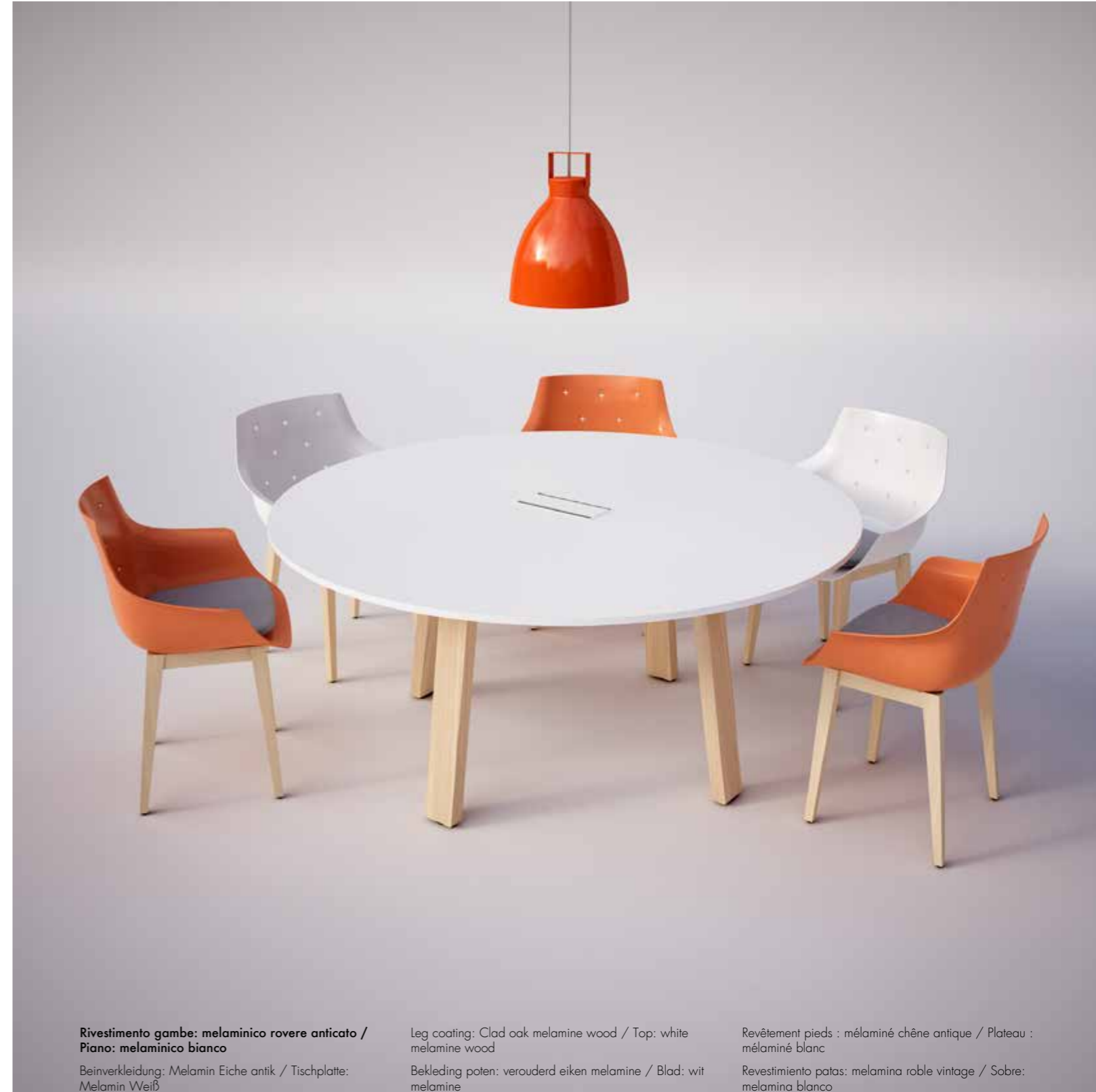

Rivestimento gambe: melaminico rovere antico /  
Piano: melaminico bianco

Beinverkleidung: Melamin Eiche antik / Tischplatte:  
Melamin Weiß

Leg coating: Clad oak melamine wood / Top: white  
melamine wood

Bekleding poten: verouderd eiken melamine / Blad: wit  
melamine

Revêtement pieds : mélaminé chêne antique / Plateau :  
mélaminé blanc

Revestimiento patas: melamina roble vintage / Sobre:  
melamina blanco



Compositions elements & dimensions

32/33 35

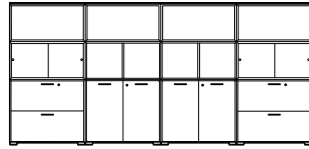

320 x 40 H.151 cm 126" x 15 3/4" H.59 1/2"

**Contentori mod. UBI EVO**

UBI EVO Containers - Cubes UBI EVO - Container UBI EVO - Containers UBI EVO -  
Contenedores UBI EVO

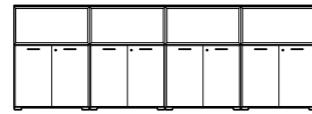

321 x 40 H.111 cm 126 1/4" x 15 3/4" H.43 3/4"

**Contentori mod. UBI EVO**

UBI EVO Containers - Cubes UBI EVO - Container UBI EVO - Containers UBI EVO -  
Contenedores UBI EVO

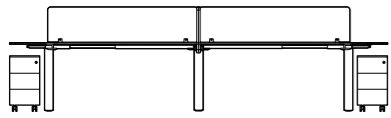

400 x 164 H.72/110 cm 157 1/2" x 64 1/2" H.28 1/4"/43 1/4"

**Composizione Bench**

Bench composition - Poste de travail - Bench-Arbeitsplatz - Samenstelling bench -  
Composición bench

31,8 x 56,3 H.58,7 cm 12 1/2" x 22" H.23"

**Cassetiera Slim**

Pedestal Slim - Caisson Slim - Slim Container - Ladenblok Slim - Cajonera Slim

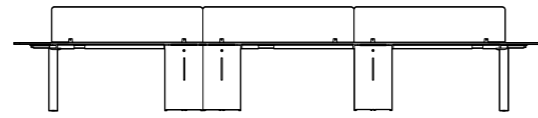

560 x 164 H.72/110 cm 220 1/2" x 64 1/2" H.28 1/4"/43 1/4"

**Composizione Bench**

Bench composition - Poste de travail - Bench-Arbeitsplatz - Samenstelling bench -  
Composición bench

160 x 1,8 H.38 cm 63" x 3/4" H.15"

**Schermo divisorio**

High screen - Écran haut - Hoher Sichtschutz - Hoog scherm - Pantalla alta

36/37 38/39 41

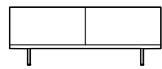

160 x 40 H.62 cm 63" x 15 3/4" H.24 1/2"

**Contentori mod. UBI EVO**

UBI EVO Containers - Cubes UBI EVO - Container UBI EVO - Containers UBI EVO -  
Contenedores UBI EVO



142 x 56 H.57 cm 56" x 22" H.22 1/2"

**Mobile di servizio mod. EKO**

Service Cabinet EKO - Meuble de service - Sideboard EKO - Serviceunit EKO - Mueble  
de servicio EKO



321 x 40 H.151 cm 126 1/4" x 15 3/4" H.59 1/2"

**Contentori mod. UBI EVO**

UBI EVO Containers - Cubes UBI EVO - Container UBI EVO - Containers UBI EVO -  
Contenedores UBI EVO



321 x 40 H.62 cm 126 1/4" x 15 3/4" H.24 1/2"

**Contentori mod. UBI EVO**

UBI EVO Containers - Cubes UBI EVO - Container UBI EVO - Containers UBI EVO -  
Contenedores UBI EVO

36/37 38/39 40



220 x 100 H.72 cm 86 3/4" x 39 1/4" H.28 1/4"

**Scrivania**

Desk - Bureau - Schreibtische - Bureau - Escritorio

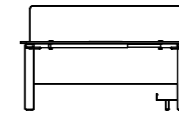

180 x 100 H.72 cm 70 3/4" x 39 1/4" H.28 1/4"

**Scrivania**

Desk - Bureau - Schreibtische - Bureau - Escritorio

160 x 1,8 H.82 cm 63" x 3/4" H.32 1/4"

**Schermo divisorio**

High screen - Écran haut - Hoher Sichtschutz - Hoog scherm - Pantalla alta

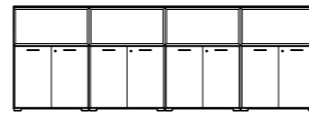

321 x 40 H.111 cm 126 1/4" x 15 3/4" H.43 3/4"

**Contentori mod. UBI EVO**

UBI EVO Containers - Cubes UBI EVO - Container UBI EVO - Containers UBI EVO -  
Contenedores UBI EVO

42/43 45



320 x 124 H.72 cm 126" x 48 3/4" H.28 1/4"

**Tavolo riunione rettangolare**

Rectangular meeting table - Table rectangulaire de réunion - Rechteckiger Konferenztisch -  
Rechthoekige vergader tafel - Mesa rectangular de reunión



Ø160 H.72 cm Ø63" H.28 1/4"

**Tavolo riunione rotondo**

Round meeting table - Table ronde de réunion - Runder Konferenztisch -  
Ronde vergader tafel - Mesa redonda de reunión

take off  
evolution

farm



# take off evolution farm

**Rivestimento gambe: melaminico rovere anticato**  
**/ Piani + mensole: melaminico rovere anticato /**  
**Schermo: vetro temperato grigio / Passacavi: tessuto**  
**Puma - Nero**

Beinverkleidung: Melamin Eiche antik / Tischplatte + Konsolen: Melamin Eiche antik / Sichtschutz: gehärtetes Glas Grau / Kabeldurchlass: Stoff Puma - Schwarz

Leg coating: Clad oak melamine wood / Tops + shelves: decapé oak melamine wood / Panel: grey tempered glass / Cable holder: Puma - Black fabric

Bekleding poten: verouderd eiken melamine / Bladen + legplanken: verouderd eiken melamine / Scherm: grijs gehard glas / Kabeldoorvoer: stof Poema - Zwart

Revêtement pieds : mélaminé chêne antique / Plateau + étagères : mélaminé chêne antique / Écran : verre trempé gris / Passe-câbles : tissu Puma - Noir

Revestimiento patas: melamina roble vintage / Sobres + ménsulas: melamina roble vintage / Pantalla: cristal templado gris / Pasacables: tejido Puma - Negro



# take off evolution farm



**Rivestimento gambe + piano: melaminico rovere anticato / Scocche cassettiere: melaminico nero / Frontali e top cassettiere: melaminico rovere anticato / Schermo: vetro temperato grigio**

Leg coating + top: oak melamine wood / Drawer shell: black melamine wood / Drawer front panels and tops: Rustic oak melamine wood / Panel: grey tempered glass

Revêtement pieds + plateau : mélaminé chêne antique / Châssis caissons: mélaminé noir / Façades et dessus caissons: mélaminé chêne antique / Écran : verre trempé gris

Beinverkleidung + Tischplatte: Melamin Eiche antik / Container-Korpus: Melamin Schwarz / Fronten und Container-abdeckung: Melamin Eiche antik / Sichtschutz: gehärtetes Glas Grau

Bekleding poten + blad: verouderd eiken melamine / Wandpanelen ladekasten: zwart melamine / Voorpanelen en top ladekasten: verouderd eiken melamine / Scherm: grijs gehard glas

Revestimiento patas + sobre: melamina roble vintage / Armazones cajoneras: melamina negro / Frontes y encimeras cajoneras: melamina roble vintage / Pantalla: cristal templado gris

# take off evolution farm

Rivestimento gambe + piano: melaminico rovere antico / Ante, fianchi e top armadio: melaminico nero

Beinverkleidung + Platte: Melamin Eiche antik / Türen, Seitenverkleidungen und Schrankoberplatte: Melamin Schwarz

Leg coating + top: Rustic oak melamine wood / Closet sides, doors and top: black melamine wood

Bekleding poten + blad: verouderd eiken melamine / Deuren, zijpanelen en top kast: zwart melamine

Revêtement pieds + plateau : mélaminé chêne antique / Façades, côtés et dessus placard : mélaminé noir

Revestimiento patas + sobre: melamina roble vintage / Puertas, costados y techo armario: melamina negro





**Rivestimento gambe + piano: melaminico rovere anticato / Ante, fianchi e top armadio: melaminico rovere anticato**

Beinverkleidung + Tischplatte: Melamin Eiche antik / Türen, Seitenverkleidungen und Schrankoberplatte: Melamin Eiche antik

Leg coating + top: decapé oak melamine wood / Closet sides, doors and top: decapé oak melamine wood

Bekleding poten + blad: verouderd eiken melamine / Deuren, zijpanelen en top kast: verouderd eiken melamine

Revêtement pieds + plateaux : mélaminé chêne antique / Façades, côtés et dessus placard : mélaminé chêne antique

Revestimiento patas + sobre: melamina roble vintage / Puertas, costados y techo armario: melamina roble vintage



**Rivestimento gambe + piano: melaminico rovere anticato / Ante, fianchi e top armadio: melaminico bianco**

Leg coating + top: decapé oak melamine wood / Closet sides, doors and top: white melamine wood

Revêtement pieds + plateaux : mélaminé chêne antique / Façades, côtés et dessus placard : mélaminé blanc

Beinverkleidung + Tischplatte: Melamin Eiche antik / Türen, Seitenverkleidungen und Schrankoberplatte: Melamin Weiß

Bekleding poten + blad: verouderd eiken melamine / Deuren, zijpanelen en top kast: wit melamine

Revestimiento patas + sobre: melamina roble vintage / Puertas, costados y techo armario: melamina blanco

**Alcuni esempi di possibili configurazioni - Some examples of possible layouts - Voici quelques exemples de configurations possibles - Einige Beispiele von möglichen Konfigurationen - Een aantal voorbeelden van mogelijke configuraties - Algunos ejemplos de configuraciones posibles**

**Per una più completa visione della collezione, consultare il listino**  
 Pour un meilleur aperçu de la collection, veuillez consulter la liste des prix  
 Om de volledige collectie te raadplegen, zie de lijst

To view the collection in more detail, Please refer to our price list  
 Eine komplette Ansicht der Kollektion finden Sie in der Preisliste  
 Para ver más detalladamente la colección, consultar la tarifa

		cm	inch	angle
<p>54/55 56</p> <p>• CM.0407.M4</p>	<p><b>Scrivania con gambe rivestite, Dattilo appeso con cassetiera portante</b>                      Desk with coated legs, Workwall legs with drawer unit                      Bureau avec pieds revêtus, Dactylo suspendu avec caisson portant                      Schreibtisch mit verkleideten Beinen, Andocktisch mit Stützcontainer                      Bureau met beklede poten, Oplegtafel met dragende ladenblok                      Escritorio con patas revestidas, Ala escritorio suspendido con cajonera portante</p>	L. 160 ÷ 200 P. 180 - 200 H. 73	L. 63" ÷ 78¾" P. 70¾" - 78¾" H. 28¾"	<p>4x</p>
	<p><b>Bench con gambe rivestite</b>                      Bench with coated legs                      Bench avec pieds revêtus                      Bench mit verkleideten Beinen                      Bench met beklede poten                      Bench con patas revestidas</p>	L. 136 ÷ 240 P. 124 - 164 H. 73	L. 53½" ÷ 94½" P. 48¾" - 64½" H. 28¾"	<p>4x</p>
	<p><b>Bench con gambe rivestite</b>                      Bench with coated legs                      Bench avec pieds revêtus                      Bench mit verkleideten Beinen                      Bench met beklede poten                      Bench con patas revestidas</p>	L. 180 ÷ 276 P. 124 - 164 H. 73	L. 70¾" ÷ 108¾" P. 48¾" - 64½" H. 28¾"	<p>4x</p>
	<p><b>Bench con gambe rivestite e 2 top access</b>                      Bench with coated legs and base and 2 top access                      Bench avec pieds revêtus et base et 2 top access                      Bench mit verkleideten Beinen und 2 Top Access                      Bench met beklede poten en 2 toegangen                      Bench con patas revestidas y 2 acceso superior</p>	L. 180 ÷ 276 P. 124 - 164 H. 73	L. 70¾" ÷ 108¾" P. 48¾" - 64½" H. 28¾"	<p>4x</p>
<p>• CM.0408.ED/ES</p>	<p><b>Bench con gambe rivestite con 2 vertical File</b>                      Bench with coated legs with 2 vertical File                      Bench avec pieds revêtus avec 2 classeurs verticaux                      Bench mit verkleideten Beinen mit 2 Vertical File                      Bench met beklede poten met 2 hangmappen                      Bench con patas revestidas con 2 archivadores verticales</p>	L. 180 ÷ 240 P. 164 H. 73	L. 70¾" ÷ 94½" P. 64½" H. 28¾"	<p>4x</p>
	<p><b>Tavolo con gambe rivestite</b>                      Table with coated legs                      Table avec pieds revêtus                      Tisch mit verkleideten Beinen                      Tafel met beklede poten                      Mesita con patas revestidas</p>	L. 220 ÷ 276 P. 100 H. 73	L. 86¾" ÷ 108¾" P. 39¾" H. 28¾"	<p>4x</p>
	<p><b>Tavolo sagomato con colonna e base e 1 top access</b>                      Shaped table with column and base and 1 top access                      Table elliptique avec colonne et base et 1 top access                      Tisch geformt mit Säule und Bodenplatte und 1 Top Access                      Gevormde tafel met kolom en basis en 1 toegang                      Mesa ovalada con columna y base y 1 acceso superior</p>	L. 220 P. 124 H. 73	L. 86¾" P. 48¾" H. 28¾"	

# take off evolution farm

Rivestimento gambe + piano: melaminico rovere  
antico

Beinverkleidung + Tischplatte: Melamin Eiche antik

Leg coating + top: decapé oak melamine wood

Bekleding poten + blad: verouderd eiken melamine

Revêtement pieds + plateau : mélaminé chêne antique

Revestimiento patas + sobre: melamina roble vintage





**Rivestimento gambe + piano: melaminico rovere anticato**

Leg coating + top: decapé oak melamine wood

Revêtement pieds + plateau : mélaminé chêne antique

Beinverkleidung + Tischplatte: Melamin Eiche antik

Bekleding poten + blad: verouderd eiken melamine

Revestimiento patas + sobre: melamina roble vintage

**Rivestimento gambe + piano: melaminico rovere anticato / Ante Ubi: laccato bordeaux, nebbia, tortora, titiano, verde natura, giallo gold, bianco**

Leg coating + top: Rustic oak melamine wood / Ubi doors: burgundy, fog, light grey, nature green, gold yellow, white lacquered wood

Revêtement pieds + plateau : mélaminé chêne antique / Façades Ubi : laqué bordeaux, brouillard, tourterelle, titane, vert nature, jaune or, blanc

Beinverkleidung + Tischplatte: Melamin Eiche antik / Türen Ubi: Lackiert Bordeaux, Nebelgrau, Taubengrau, Naturgrün, Goldgelb, Weiß

Bekleding poten + blad: verouderd eiken melamine / Deuren Ubi: gelakt bordeaux, mistkleur, duifgrijs, titanium, natuurgroen, goudgeel, wit

Revestimiento patas + sobre: melamina roble vintage / Puertas Ubi: lacado burdeos, niebla, gris ceniciento, titanio, verde naturaleza, amarillo gold, blanco





# take off evolution country + flipper

**Rivestimento gambe: melaminico rovere antico / Piano: melaminico bianco / Mobile con ante scorrevoli: melaminico bianco / Flipper: melaminico bianco**

Beinverkleidung: Melamin Eiche antik / Tischplatte: Melamin Weiß / Sideboard mit Schiebetüren: Melamin Weiß / Flipper: Melamin Weiß

Leg coating: decapé oak melamine wood / Top: white melamine wood / Cabinets with sliding doors: white melamine wood / Flipper: white melamine wood

Bekleding poten: verouderd eiken melamine / Blad: wit melamine / Meubel met schuifdeuren: wit melamine / Flipper: wit melamine

Revêtement pieds : mélaminé chêne antique / Plateau : mélaminé blanc / Meuble avec portes coulissantes : mélaminé blanc / Flipper : mélaminé blanc

Revestimiento patas: melamina roble vintage / Sobre: melamina blanco / Mueble con puertas correderas: melamina blanco / Flipper: melamina blanco



Compositions elements & dimensions

50/51 52/53



180 x 100 H.73 cm 70 3/4" x 39 1/4" H.28 3/4"

**Scrivanica con passacavi verticale in tessuto**

Desk with Vertical fabric cable tray - Bureau avec Câblage vertical en tissu - Schreibtische mit Senkrechter Kabelführung aus Stoff - Bureau met Verticale stoffen kabelgoot - Escritorio con Pasacables vertical en tejido

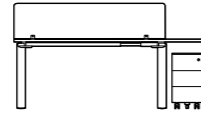

200 x 164 H.73/110 cm 78 3/4" x 64 1/2" H.28 3/4"/43 1/4"

**Composizione Bench**

Bench composition - Poste de travail - Bench-Arbeitsplatz - Samenstelling bench - Composición bench

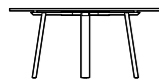

Ø160 H.73 cm Ø63" H.28 3/4"

**Tavolo riunione rotondo**

Round meeting table - Table ronde de réunion - Runder Konferenztisch - Ronde vergadertafel - Mesa redonda de reunión



80/100/120 x 25 H.3 cm 31 1/2"/39 1/4"/47 1/4" x 9 3/4" H.1"

**Mensole a parete**

Wall shelf - Étagères murales - Konsole für Wandmontage - Plank wandmontage - Estante fijación mural

58/59 60/61

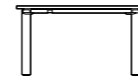

136 x 124 H.73 cm 53 1/2" x 48 3/4" H.28 3/4"

**Tavolo riunione mod. FARM**

FARM Meeting table - Table de reunion FARM - Konferenztisch FARM - Vergadertafel FARM - Mesa de reunión FARM



Ø140 H.73 cm Ø55" H.28 3/4"

**Tavolo riunione rotondo mod. FARM**

FARM Round meeting table - Table ronde de reunion FARM - Runder Konferenztisch FARM - Ronde vergadertafel FARM - Mesa redonda de reunión FARM

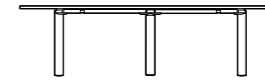

276 x 124/164 H.73 cm 108 3/4" x 48 3/4"/64 1/2" H.28 3/4"

**Tavolo riunione mod. FARM**

FARM Meeting table - Table de reunion FARM - Konferenztisch FARM - Vergadertafel FARM - Mesa de reunión FARM



68/136 x 36 H.44 cm 26 3/4"/53 1/2" x 14" H.17 1/4"

**Panchetta**

Bench - Tabouret - Sitzbank - Krukje - Banqueta

66 x 34 H.3 cm 26" x 13 1/4" H.1"

**Cuscini imbottiti**

Cushion - Coussin - Sitzpolster - Kussen - Cojín

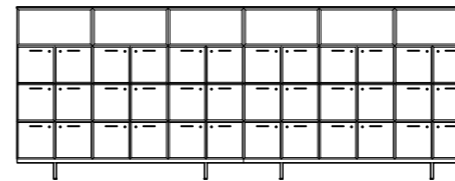

482 x 40 H.184 cm 189 3/4" x 15 3/4" H.72 1/2"

**Contentitori mod. UBI EVO**

UBI EVO Containers - Cubes UBI EVO - Container UBI EVO - Containers UBI EVO - Contenedores UBI EVO

54/55 56

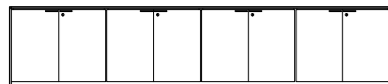

404 x 46 H.83 cm 159" x 18" H.32 3/4"

**Armadio mod. A100**

A100 Cabinet - Armoire A100 - Schränke A100 - Kasten A100 - Armario A100



280 x 124 H.73 cm 110 1/4" x 48 3/4" H.28 3/4"

**Tavolo riunione rettangolare**

Rectangular meeting table - Table rectangulaire de réunion - Rechteckiger Konferenztisch - Rechthoekige vergadertafel - Mesa rectangular de reunión

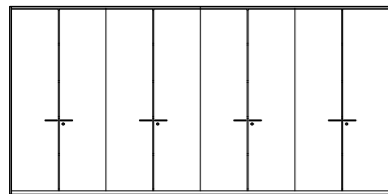

400 x 46 H.198 cm 159" x 18" H.78"

**Armadio mod. A100**

A100 Cabinet - Armoire A100 - Schränke A100 - Kasten A100 - Armario A100

62/63

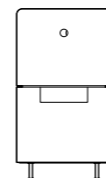

100 x 34 H.180 cm 39 1/4" x 13 1/4" H.70 3/4"

**Mod. FLIPPER a parete**

Flipper with wall fixing - Flipper avec fixation murale - Wand Flipper - Flipper voor wandmontage - Flipper a pared

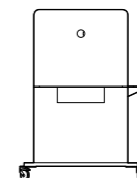

120 x 40 H.180 cm 47 1/4" x 15 3/4" H.70 3/4"

**Mod. FLIPPER su ruote**

Flipper on castors - Flipper sur roulettes - Flipper auf Rollen - Flipper op wielen - Flipper sobre ruedas

48 x 28 H.1,8 cm 18 3/4" x 11" H.3/4"

**Mensola Flipper**

Flipper shelf - Étagère pour Flipper - Konsole für Flipper - Plank voor Flipper - Estante para Flipper

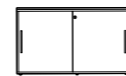

120 x 40 H.72 cm 47 1/4" x 15 3/4" H.28 1/4"

**Mobile con ante scorrevoli**

Cabinet with sliding doors - Meuble avec portes coulissantes - Sideboard mit Schiebetüren - Meubel met schuifdeuren - Mueble con puertas correderas

120 x 40 H.1,8 cm 47 1/4" x 15 3/4" H.3/4"

**Top mobile**

Finishing top for sliding doors cabinet - Top pour meuble avec portes coulissantes - Abdeckplatte für Schiebetürenschränk - Topblad voor meubel met schuifdeuren - Tapa para mueble puertas correderas



take off  
evolution country

220 x 124 H.72 cm 86 3/4" x 48 3/4" H.28 1/4"

**Tavolo riunione sagomato**

Shaped meeting table - Table elliptique de réunion - Geformter Konferenztisch - Gevormde vergadertafel - Mesa con forma de reunión

take off  
evolution

technical

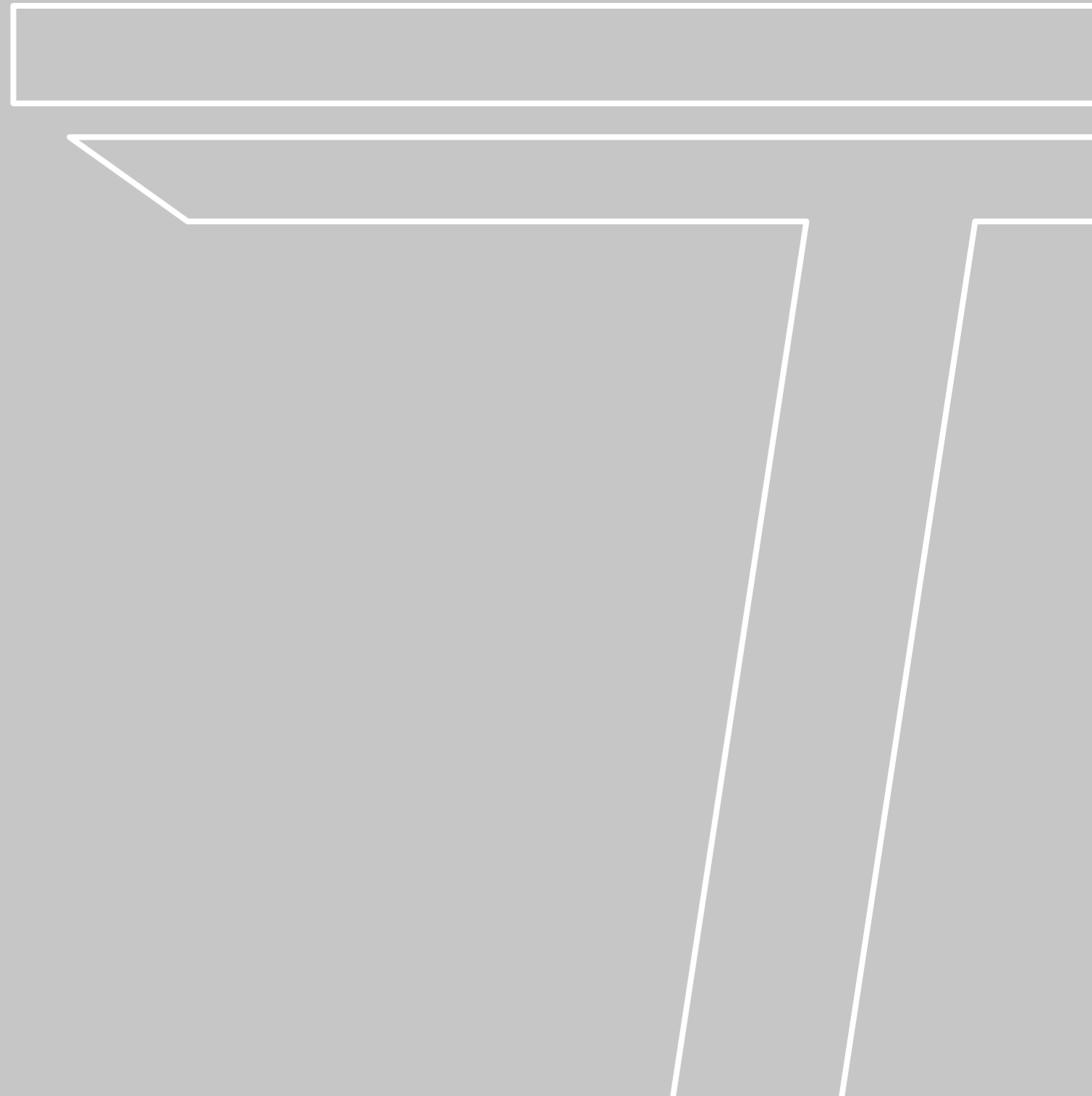

**Tipologie schermi - Types of panels - Types d'écrans - Sichtschutz-Typen - Schermtypen - Tipos de pantallas**

Per una più completa visione della collezione, consultare il listino  
Pour un meilleur aperçu de la collection, veuillez consulter la liste des prix  
Om de volledige collectie te raadplegen, zie de lijst

To view the collection in more detail, Please refer to our price list  
Eine komplette Ansicht der Kollektion finden Sie in der Preisliste  
Para ver más detalladamente la colección, consultar la tarifa

**Schermi divisori - Screens dividers - Écrans de séparation frontale - Sichtschutzpaneele - Schermverdeling - Pantalla separadora**

	<p><b>Schermo divisorio vetro sp 8 mm / 0¼"</b> Glass screen 8 mm / 0¼" thick Écran de séparation frontale verre ép. 8 mm / 0¼" Sichtschutzpaneel Glas Stärke 8 mm / 0¼" Glazen schermverdeling dikte 8 mm / 0¼" Pantalla separadora de cristal esp. 8 mm / 0¼"</p>		<p><b>Schermo divisorio laccato sp 18 mm / 0¾"</b> Lacquered screen 18 mm / 0¾" thick Écran de séparation frontale laqué ép. 18 mm / 0¾" Sichtschutzpaneel lackiert Stärke 18 mm / 0¾" Gelakte schermverdeling dikte 18 mm / 0¾" Pantalla separadora lacada esp. 18 mm / 0¾"</p>		<p><b>Schermo divisorio melaminico sp 18 mm / 0¾"</b> Melamine screen 18 mm / 0¾" thick Écran de séparation frontale mélaminé ép. 18 mm / 0¾" Sichtschutzpaneel Melamin Stärke 18 mm / 0¾" Schermverdeling in melamine dikte 18 mm / 0¾" Pantalla separadora melamina esp. 18 mm / 0¾"</p>
--	---	---	--	--	--

	<p><b>Schermo divisorio in tessuto sp 18 mm / 0¾" con profilo</b> Fabric screen 18 mm / 0¾" thick with profile Écran de séparation frontale en tissu ép. 18 mm / 0¾" avec profil Sichtschutzpaneel aus Stoff Stärke 18 mm / 0¾" mit Profil Stoffen schermverdeling dikte 18 mm / 0¾" met profiel Pantalla separadora de tejido esp. 18 mm / 0¾" con perfil</p>		<p><b>Schermo divisorio in tessuto fonoassorbente sp 42 mm / 1¾" con profilo</b> Sound-absorbing fabric screen 42 mm / 1¾" thick with profile Écran de séparation frontale en tissu insonorisant ép. 42 mm / 1¾" avec profil Sichtschutzpaneel aus schallschluckendem Stoff Stärke 42 mm / 1¾" mit Profil Schermverdeling in geluiddempende stof dikte 42 mm / 1¾" met profiel Pantalla separadora de tejido fonoabsorbente esp. 42 mm / 1¾" con perfil</p>
---	--	--	---

**Schermi divisori laterali - Side screens dividers - Écrans de séparation latérale - Seitliche Sichtschutzpaneele - Schermverdeling zijkant - Pantalla separadora lateral**

	<p><b>Schermo divisorio laterale laccato sp 18 mm / 0¾"</b> Lacquered side screen 18 mm / 0¾" thick Écran de séparation latérale laqué ép. 18 mm / 0¾" Seitliches Sichtschutzpaneel lackiert Stärke 18 mm / 0¾" Gelakte schermverdeling zijkant dikte 18 mm / 0¾" Pantalla separadora lateral lacada esp. 18 mm / 0¾"</p>		<p><b>Schermo riposizionabile in tessuto fonoassorbente sp 42 mm / 1¾"</b> Fabric side screen 42 mm / 1¾" thick Écran de séparation latérale en tissu ép. 42 mm / 1¾" Seitliches Sichtschutzpaneel aus schallschluckendem Stoff Tiefe 42 mm / 1¾" Stoffen schermverdeling zijkant dikte 42 mm / 1¾" Pantalla separadora lateral de tejido esp. 42 mm / 1¾"</p>
--	---	---	--

**Schermi frontali - Front screens - Écrans frontal - Frontaler Sichtschutz - Scherm voorkant - Pantalla frontal**

	<p><b>Schermo frontale melaminico sp. 18 mm / 0¾"</b> Front melamine wood screen 18 mm / 0¾" thick Écran frontal mélaminé ép. 18 mm / 0¾" Frontaler Sichtschutz Melamin Stärke 18 mm / 0¾" Scherm voorkant melamine dikte 18 mm / 0¾" Pantalla frontal melamina esp. 18 mm / 0¾"</p>		<p><b>Schermo frontale tessuto sp. 18 mm / 0¾"</b> Front fabric screen 18 mm / 0¾" thick Écran frontal en tissu ép. 18 mm / 0¾" Frontaler Sichtschutz aus Stoff Stärke 18 mm / 0¾" Scherm voorkant in stof dikte 18 mm / 0¾" Pantalla frontal de tejido esp. 18 mm / 0¾"</p>		<p><b>Schermo frontale alto melaminico sp. 18 mm, 0¾"</b> Front high melamine wood screen 18 mm / 0¾" thick Écran frontal haut mélaminé ép. 18 mm / 0¾" Frontaler Hoher Sichtschutz Melamin Stärke 18 mm / 0¾" Hoog scherm voorkant melamine dikte 18 mm / 0¾" Pantalla frontal alta melamina esp. 18 mm / 0¾"</p>
--	--	---	--	--	--

**Possibili posizioni degli schermi sui piani - Possible screen positions on the tops - Positions possibles des écrans sur les plateaux - Mögliche Aufstellungen der Sichtschutzpaneele auf den Tischplatten - Mogelijke posities van de schermen op de bladen - Posibles posiciones de las pantallas en los sobres**

Per una più completa visione della collezione, consultare il listino  
Pour un meilleur aperçu de la collection, veuillez consulter la liste des prix  
Om de volledige collectie te raadplegen, zie de lijst

To view the collection in more detail, Please refer to our price list  
Eine komplette Ansicht der Kollektion finden Sie in der Preisliste  
Para ver más detalladamente la colección, consultar la tarifa

**Piano da 4 postazioni - Desk top 4 positions - Bureau 4 positions - Platte für 4 Arbeitsplätze - Bureau top 4 posities - Escritorio 4 posiciones**



**Piano da 2 postazioni - Desk top 2 positions - Bureau 2 positions - Platte für 2 Arbeitsplätze - Bureau top 2 posities - Escritorio 2 posiciones**



**Piano da 1 postazione - Desk top 1 position - Bureau 1 position - Platte für 1 Arbeitsplatz - Bureau top 1 posities - Escritorio 1 posición**



**Piano da 1 postazione - Desk top 1 position - Bureau 1 position - Platte für 1 Arbeitsplatz - Bureau top 1 posities - Escritorio 1 posición**



**Sistemi per il passaggio cavi e per l'elettificazione dei piani** - Cable holding and top electrification systems - Systèmes passe-câbles et pour l'électrification des plateaux - Systeme für Kabeldurchlass und Elektrifizierung der Tischplatten - Kabeldoorvoersystemen en bekabelingssystemen van de bladen - Sistemas para el paso de los cables y para la electrificación de los sobres



**salita cavi tramite vertebra**  
vertebra cable holder / vertèbre montée de câbles / Kabelaufgang durch Spirale / omhoogwerking kabels via geleider / ascenso de los cables mediante vértebra

**l'ampio alloggiamento nel cestello sottopiano permette di mantenere ordinati e facilmente ispezionabili tutti i cavi e le connessioni**  
the wide under-top tray houses all the cables and connections, allowing you to inspect them at any time / le large logement dans le bac sous le plateau permet de maintenir rangé et facile d'accès tous les câbles et connexions / Der geräumige Platz des Unterbaukorbes ermöglicht Ordnung und Inspizierbarkeit aller Kabel und Anschlüsse / dankzij de ruime kabelhouder onder het blad kunnen alle kabels en verbindingen ordelijk bewaard worden en kunnen ze eenvoudig gecontroleerd worden / el amplio alojamiento de la cesta presente bajo el sobre permite mantener en orden todos los cables y las conexiones facilitando su inspección

**salita cavi attraverso la gamba centrale: pannello riposizionabile per una facile ispezionabilità dell'alloggiamento e foro passacavi**  
cable holder in the central leg: easily detachable panel to inspect the cable holder hole and housing / montée des câbles à travers le pied central : panneau repositionnable pour faciliter l'inspection du logement et passe-câbles / Kabelaufgang durch das zentrale Bein mit einer abnehmbaren Blende zwecks einfacher Inspektion, und Kabeldurchlass / omhoogwerking kabels via de centrale poot: herpositioneerbaar paneel voor een eenvoudige inspectie van de houder en de kabeldoorvoeropening / ascenso de los cables a través de la pata central: panel desplazable para facilitar la inspección del alojamiento y orificio pasacables

**uscita cavi sul piano tramite top access**  
cable duct tray with top access / sortie des câbles sur le dessus au travers un top access / Kabeldurchführung auf der Tischplatte durch Top Access / kabeluitgang op het blad via toegang / salida de los cables en el sobre mediante top access

**Per una più completa visione della collezione, consultare il listino**  
Pour un meilleur aperçu de la collection, veuillez consulter la liste des prix  
Om de volledige collectie te raadplegen, zie de lijst

To view the collection in more detail, Please refer to our price list  
Eine komplette Ansicht der Kollektion finden Sie in der Preisliste  
Para ver más detalladamente la colección, consultar la tarifa

**uscita cavi sul piano tramite top access**  
cable duct tray with top access / sortie des câbles sur le dessus au travers un top access / Kabeldurchführung auf der Tischplatte durch Top Access / kabeluitgang op het blad via toegang / salida de los cables en el sobre mediante top access

**alloggiamento in filo metallico sottopiano per la raccolta dei cavi**  
metal wire mesh cable housing underneath the top / logement en fil métallique au-dessous de la partie supérieure pour la collecte des câbles / Unterbau-Gitterbehälter zur Unterbringung der Kabel / houder in metaaldraad onder het blad om de kabels op te vangen / alojamiento de metálico bajo el sobre para recoger los cables



**ampia vaschetta in filo metallico per la raccolta dei cavi ed una loro facile ispezionabilità**  
large wire mesh cable tray, which allows you to inspect them at any time / grand bac en fils métalliques pour la collecte des câbles et pour faciliter leur inspection / Geräumiger Unterbau-Gitterbehälter zur Unterbringung der Kabel und einfachen Inspektion / ruim bakje in metaaldraad om de kabels op te vangen en moeiteloos te kunnen inspecteren / amplia bandeja metálica para recoger los cables facilitando su inspección

**salita cavi tramite vertebra**  
vertebra cable holder / colonne montée des câbles / Kabelaufgang durch Spirale / omhoogwerking kabels via geleider / ascenso de los cables mediante vértebra

**uscita cavi sul piano tramite top access**  
cable duct tray with top access / sortie des câbles sur le plateau au travers un top access / Kabeldurchführung auf der Tischplatte durch Top Access / kabeluitgang op het blad via toegang / salida de los cables en el sobre mediante top access

**la salita cavi può avvenire tramite un apposito passaggio sul lato della piantana, oppure direttamente all'interno della stessa**  
cables can be conveyed through a special housing on the side of the table base or directly within it / la montée des câbles peut avoir lieu à travers un passage spécial sur le côté du pied, ou directement à sa base / Der Kabelaufgang erfolgt durch die entsprechende Bohrung seitlich der Mittelsäule oder wahlweise direkt in Inneren der Säule / de kabels kunnen omhoog gewerkt worden via een speciale opening aan de kant van de staande lamp, of rechtstreeks erin / los cables pueden subir a través de un orificio a un lado de la columna de apoyo o directamente por el interior de la misma



**Flipper, struttura e sistema di elettrificazione - Flipper, structure and electrification system - Flipper, structure et système d'électrification - Flipper, Struktur und Elektrifizierungssystem - Flipper, structuur en bekabelingssysteem - Flipper, estructura y sistema de electrificación**

**i cavi elettrici e i dati entrano dal basso o da appositi passaggi laterali e sono resi disponibili in diverse posizioni per alimentare il TV sul pannello frontale, oppure un tablet sulla mensola dedicata o ancora una web cam collocabile sulla parte superiore**

electric and data cable enter from the bottom or through special side holes, and are available in different position to supply the Tv on the front panel, or a tablet on the special shelf, or a webcam which can be connected on the rear section / les câbles électriques et de données entrent par le bas ou par des passages latéraux spéciaux et ils sont mis à disposition dans des positions différentes pour alimenter le téléviseur sur le panneau avant, ou une tablette sur la console dédiée ou même une webcam pouvant être placée sur la partie supérieure / Elektrische Kabel oder Datenleitungen kommen von unten oder durch seitliche Öffnungen und sind in mehreren Positionen verfügbar zur Versorgung eines Fernsehers auf der Frontblende, eines Tablets auf der entsprechenden Konsole oder einer Webcam, die auf der oberen Seite positioniert werden kann / de voedings- en gegevenskabels komen van onderen naar binnen of door speciaal hiervoor bestemde openingen aan de zijkant en worden beschikbaar gemaakt in verschillende posities om de televisie op het voorpaneel te voeden, of een tablet op de hiervoor bestemde plank of een webcam die op het bovengedeelte geplaatst kan worden / los cables eléctricos y de datos entran por abajo o por unos orificios laterales y resultan disponibles en distintas posiciones para alimentar la TV en el panel frontal, una tableta en el estante correspondiente o una cámara web colocada en la parte superior

**il pannello svolge anche la funzione di lavagna scrivibile**

the panel is also a blackboard / le panneau sert également de tableau blanc / Die Blende hat auch die Funktion einer beschriftbaren Tafel / het paneel doet ook dienst als beschrijfbaar bord / el panel desempeña también la función de pizarra escribible

**i pannelli sono facilmente riposizionabili per un agevole posizionamento, controllo o manutenzione dei cavi all'interno**

all panels can be easily detach to place, check or service the cables inside / les panneaux peuvent être facilement repositionnés pour faciliter le positionnement, le contrôle ou l'entretien des câbles à l'intérieur / Die Blenden sind mühelos abnehmbar für eine einfache Inspektion und wartung der Kabel im Innenraum / de panelen kunnen gemakkelijk geherpositioneerd worden voor een gemakkelijke plaatsing, controle of onderhoud van de interne kabels / los paneles pueden desplazarse cómodamente para facilitar la colocación, el control o el mantenimiento de los cables presentes en el interior

**ruote di ampie dimensioni per una agevole traslazione, dotate di blocco**

wide wheels with locking brake / grandes roues pour un déplacement aisé, équipées de frein / große Laurollen für eine einfache Bewegung, ausgestattet mit Arretierung / grote wielen voor een vlotte verplaatsing, met blokkering / ruedas de amplias dimensiones para facilitar el desplazamiento, dotadas de bloqueo

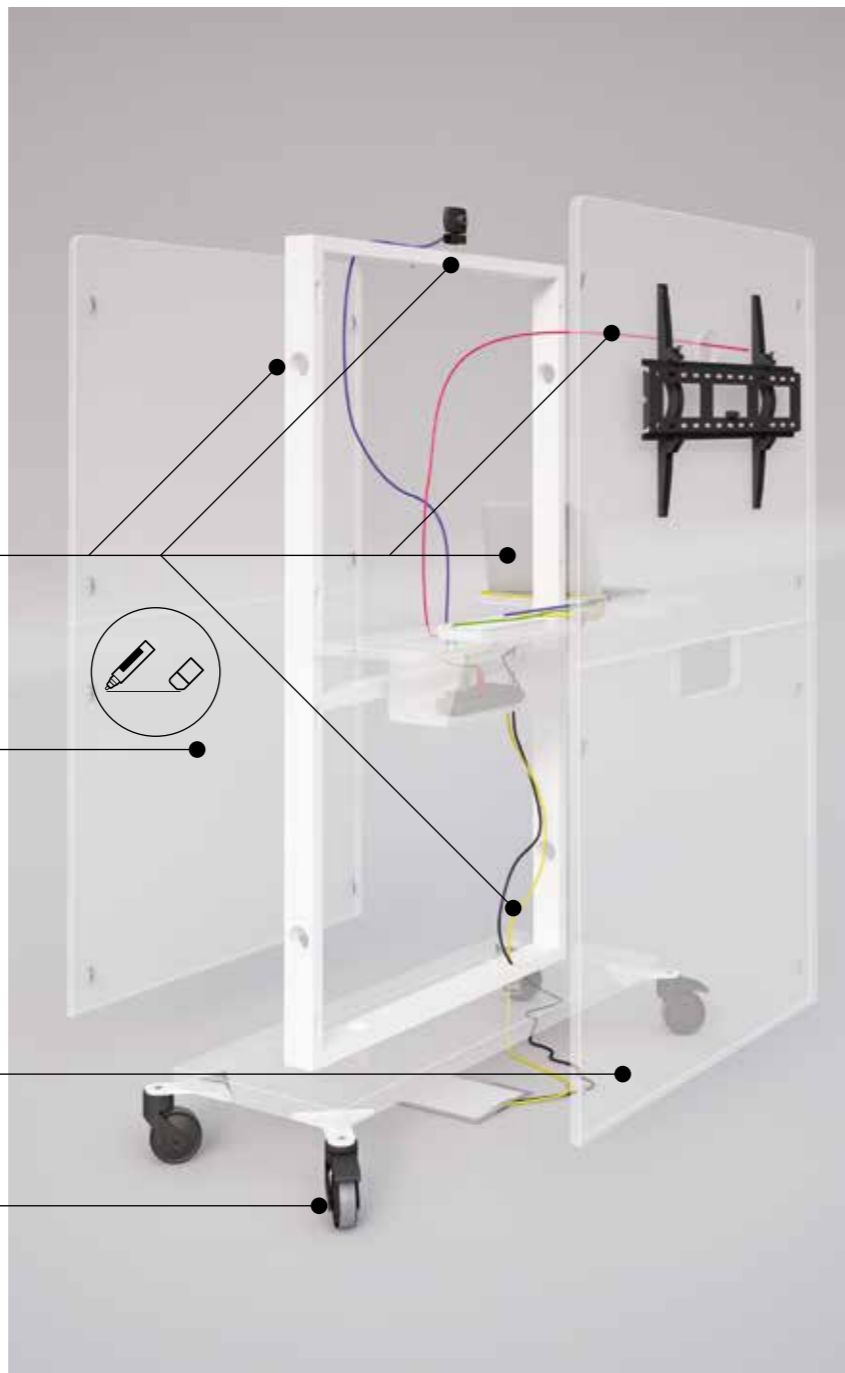

**i cavi di alimentazione e dati possono entrare dagli appositi passaggi Flipper, alimentare i vari devices presenti ed essere resi disponibili anche per il piano meeting**

electric and data cable enter from the special holes on Flipper holes, to supply the different devices, and can be extended also to the meeting table / les câbles d'alimentation et de données peuvent entrer par des passages spéciaux du Flipper, alimenter les divers appareils électriques présents et être mis à disposition également pour le dessus de la table de réunion / elektrische Kabel und Datenleitungen für Geräte können durch vorgesehene Öffnungen von Flipper eingeführt werden, und auch auf der Tischplatte verfügbar sein / de voedings- en gegevenskabels kunnen door de speciaal hiervoor bedoelde geleidingen van Flipper gestoken worden, de verschillende aanwezige toestellen voeden en ook beschikbaar zijn op het vergaderblad / los cables de alimentación y de datos pueden entrar por los orificios correspondientes de Flipper, alimentar los distintos dispositivos y resultar también disponibles para el sobre de la mesa de reuniones

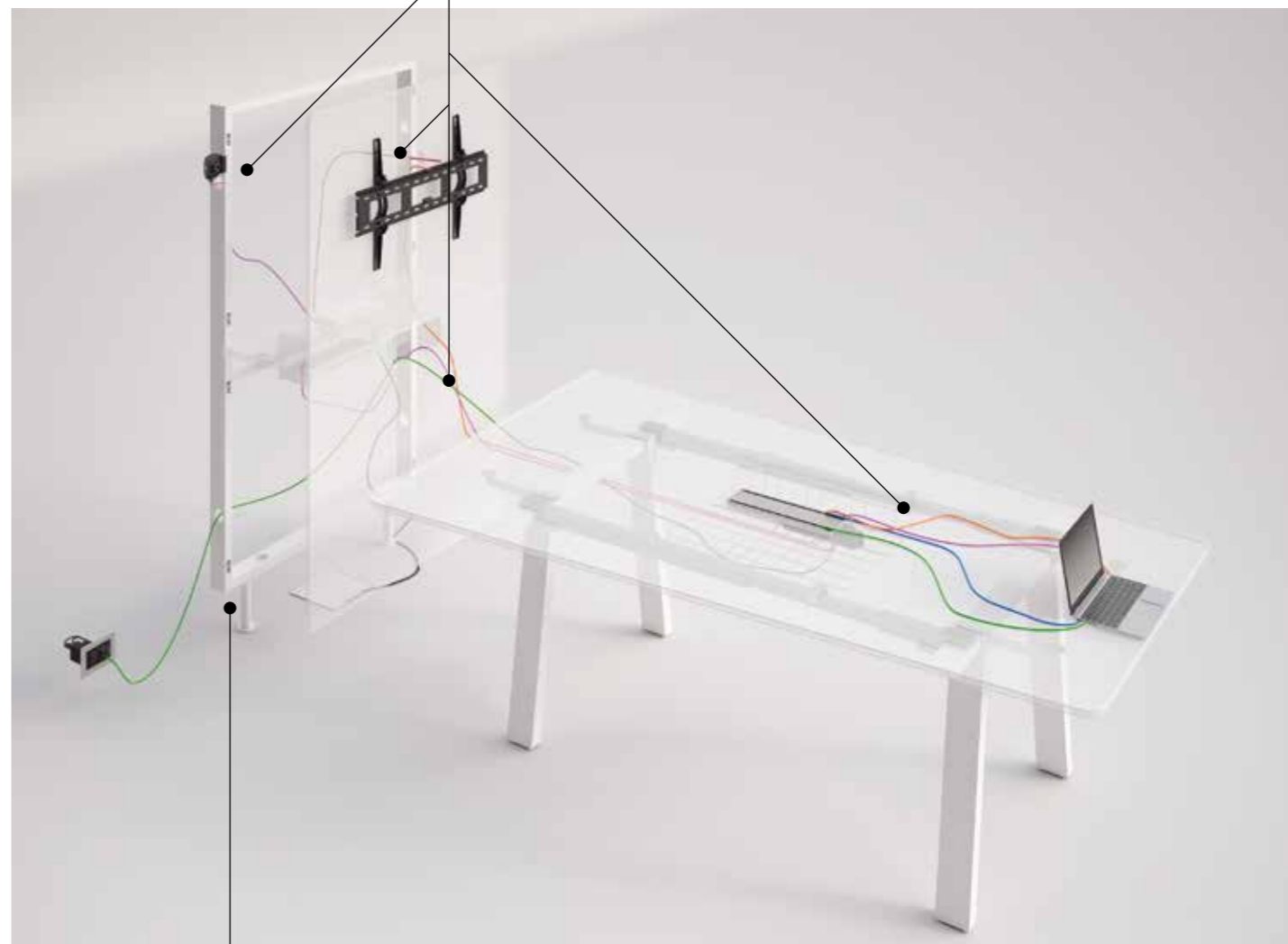

**Flipper, nella versione a muro, è dotato di piedini di sostegno e regolazione**

the wall version of Flipper is equipped with support and adjustment feet / Flipper, dans sa version murale, est équipé de pieds de support réglables / Flipper in der Wandausführung ist mit Stütz- und Justierfüßchen ausgestattet / de muurversie van Flipper beschikt over ondersteunende en afstelbare poten / en la versión de pared, Flipper está dotado de patas de soporte y regulación

**Per una più completa visione della collezione, consultare il listino**  
Pour un meilleur aperçu de la collection, veuillez consulter la liste des prix  
Om de volledige collectie te raadplegen, zie de lijst

To view the collection in more detail, Please refer to our price list  
Eine komplette Ansicht der Kollektion finden Sie in der Preisliste  
Para ver más detalladamente la colección, consultar la tarifa

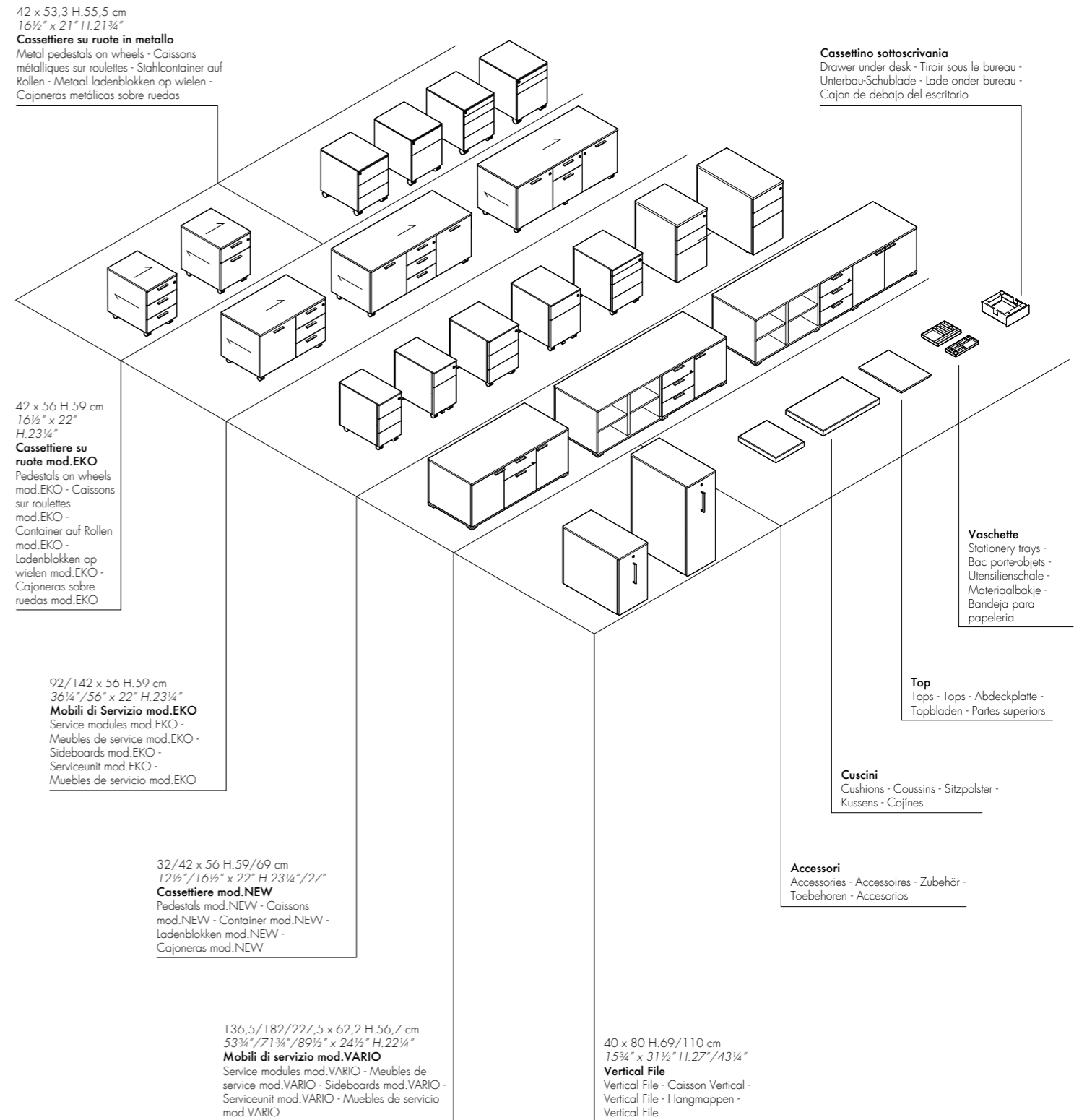
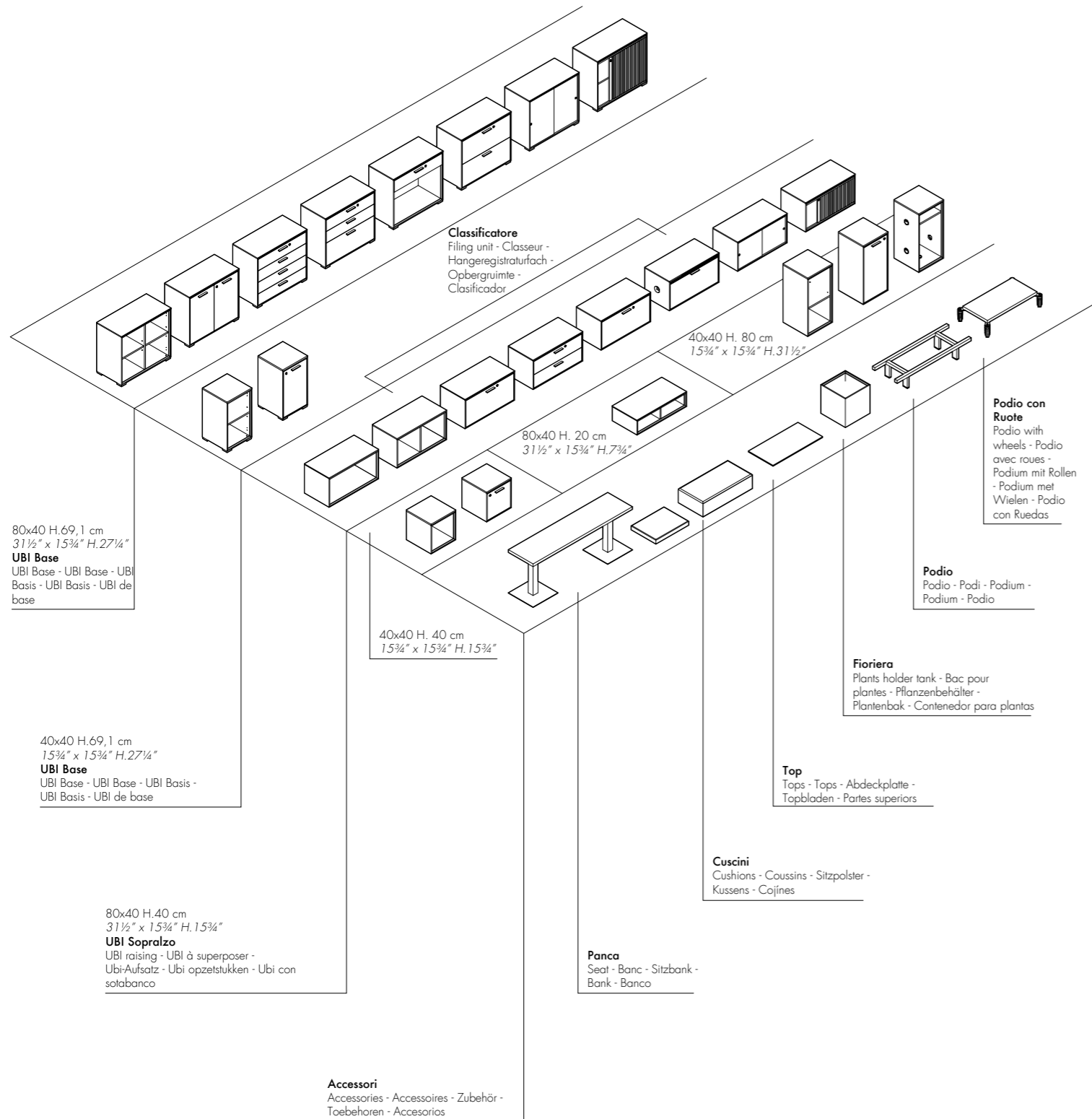

**Armadi A100 p.36 cm / 14"** - A100 closet system - d. 36 / 14" - Système de placards A100 - p. 36/14" - Schranksystem A100 - Tiefe 36/14" - System Kasten A100 - d. 36/14" - Sistema Armarios A100 - p. 36/14"

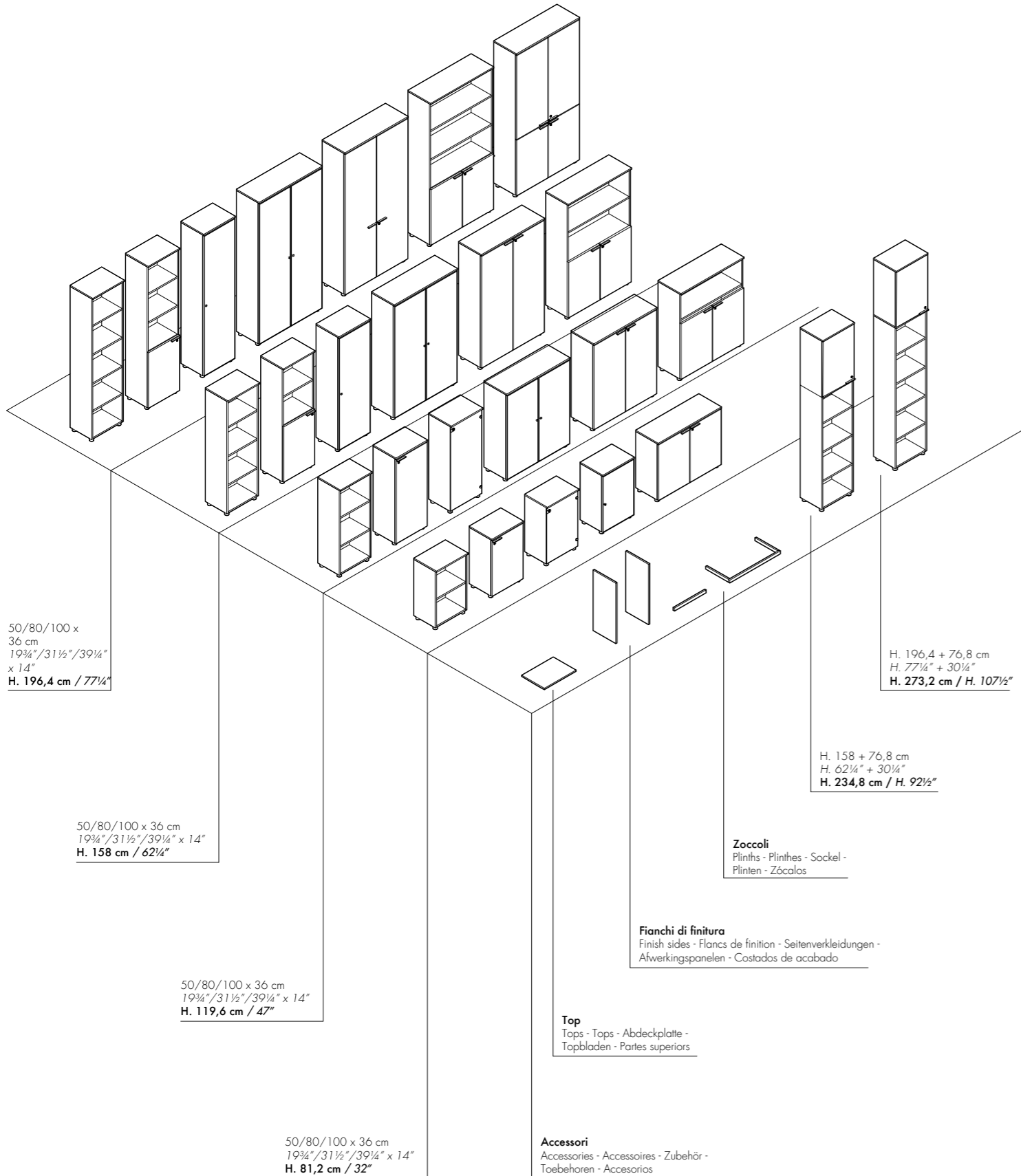

**Armadi A100 p.46 cm / 18"** - A100 closet system - d. 46 / 18" - Système de placards A100 - p. 46/18" - Schranksystem A100 - Tiefe 46/18" - System Kasten A100 - d. 46/18" - Sistema Armarios A100 - p. 46/18"

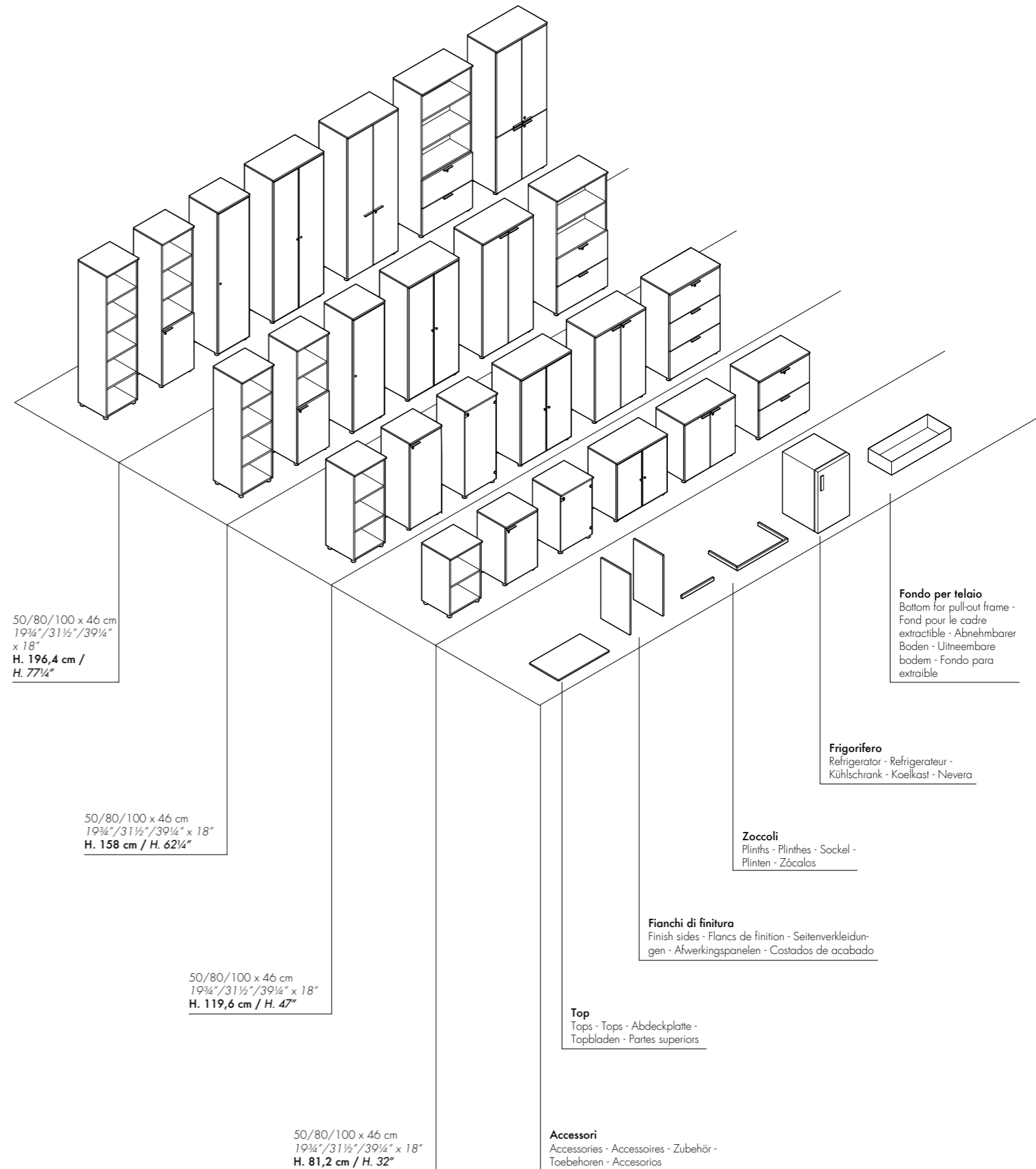



**Accessori - Accessories - Accessoires - Zubehör - Accessoires - Accesorios**

**Tappo passacavi - Cable access port - Passe-câbles - Kabeldurchlass - Kabeldoorgang - Tapon pasacables**



GZ.0008.B0  
**Tappo passacavi quadrato**  
Square cable access port  
Passe-câbles carré  
Quadratischer Kabeldurchlass  
Vierkante kabeldoorgang  
Tapon pasacables cuadrado



GZ.0008.A0  
**Tappo passacavi rotondo**  
Round cable access port  
Passe-câbles rond  
Runder Kabeldurchlass  
Ronde kabeldoorvoer  
Tapon pasacables redondo

**Top access - Top access - Top access - Top-Access - Top toegang - Acceso superior**



GZ.0058.A2  
**Top access per piano scrivania**  
Top access  
Top access  
Top-Access  
Top toegang  
Acceso superior



GZ.0024.A1/A3 + GZ.0012.EU/.FR/.UK  
**Top access + Kit blocco portaprese**  
Top access + Kit foldway socket holde  
Top access + Kit bloc porte-prises  
Top-Access+ Elektro-Dosenblock  
Top toegang + Kit power unit  
Acceso superior + Kit de bloque portaenchufe



GZ.0062.A3  
**Top access**  
Top access  
Top access  
Top-Access  
Top toegang  
Acceso superior

Per una più completa visione della collezione, consultare il listino  
Pour un meilleur aperçu de la collection, veuillez consulter la liste des prix  
Om de volledige collectie te raadplegen, zie de lijst

To view the collection in more detail, Please refer to our price list  
Eine komplette Ansicht der Kollektion finden Sie in der Preisliste  
Para ver más detalladamente la colección, consultar la tarifa

**Cestelli portacavi - Cables holder baskets - Bac porte-cables - Kabel-hartekorb - Korfjes voor elektrische bedrading - Cestos portaenchufes**



GZ.0018.00 GZ.0048.01  
**Cestelli portacavi ruotabile ed ispezionabile**  
Cables holder baskets rolling and inspectionable  
Bac porte-cables basculant  
Kabel halterkorb, schwenk-und einsehbar  
Draaibare en controleerbare korfjes voor elektrische bedrading  
Cestos portaenchufes que se vuelta e inspeccionar



GZ.0063.01 GZ.0064.01



GZ.0040.01 GZ.0026.01

**Portaprese - Socket-holder - Porte-prises - Elektro-Dosenblock - Stekker - Conector**



GZ.0057.AE/.AF/.AU  
**Blocco portaprese Versapad**  
Foldway socket holder Versapad  
Boîtier de prises Versapad  
Elektro-Dosenblock  
Ingewerkte contactdoos Versapad  
Base de conexiones Versapad



GZ.0066.A1  
**Caricabatterie Wireless**  
Wireless charger  
Chargeur sans fil  
Wireless-Ladegerät  
Draadloze oplader  
Cargador inalámbrico



GZ.0020.A0/.AF  
**Torretta portaprese a scomparsa**  
Pop up cable management tower cover  
Tourelle porte-prises  
Versenkbare Steckdosenturm  
Power unit voor aansluitingen op het schrijfblad  
Torre porta enchufe de corriente oculta



GZ.0047.EU/.FR/.UK  
**Blocco portaprese**  
Socketholder block  
Bloc de porte-prises  
Elektro-Dosenblock  
Stekker blok  
Bloque conector



GZ.0019.A0/.AF  
**Blocco portaprese a scomparsa**  
Foldway cable management module  
Bloc porte-prises  
Versenkbare Dosenblock  
Power unit voor aansluitingen  
Bloque porta enchufe de corriente oculta

**Accessori - Accessories - Accessoires - Zubehör - Accessoires - Accesorios**

**Per una più completa visione della collezione, consultare il listino**  
Pour un meilleur aperçu de la collection, veuillez consulter la liste des prix  
Om de volledige collectie te raadplegen, zie de lijst

To view the collection in more detail, Please refer to our price list  
Eine komplette Ansicht der Kollektion finden Sie in der Preisliste  
Para ver más detalladamente la colección, consultar la tarifa

**Passacavi - Cables-carrier - Passage de câbles - Kabeldurchlass - Kabeldoorvoer - Pasacables**



BZ.0072.00  
**Passacavi**  
Cables-carrier  
Montée de câbles  
Kabeldurchlass  
Kabeldoorvoer  
Pasacables



GZ.0070.01



GZ.0059.01  
**Passacavi in tessuto Puma**  
Vertical fabric Puma cable tray  
Câblage vertical en tissu Puma  
Senkrechte Kabelführung aus Stoff Puma  
Verticale stoffen Puma kabelgoot  
Pasacables vertical en tejido Puma



BZ.0060.C0  
**Colonnina salita cavi autonoma**  
Self-standing cable-riser column  
Colonne montée câbles autonome  
Kabelaufgangssäule  
Kolom voor opwaardse van de kabels  
Columna de subida de los cables autónoma



GZ.0021.00  
**Porta cpu metallico (appeso alla gamba)**  
Cpu holder (suspended to the leg)  
Porte UC en métal (suspendu à la jambe)  
Computerträger mit Beinaufhängung  
Metalen cpu-houder (bevestigd aan het been)  
Porta cpu metálico (colgado a la pata)

**Braccio portavideo - Adjustable monitor arm - Bras porte-écran - Monitor-Trägerarm - Regelbare monitorarm - Brazo-soporte para monitor**



GZ.0081.M1  
**Braccio portavideo con morsetto**  
Adjustable monitor arm with clamp  
Bras porte-écran avec pince  
Monitor-Trägerarm mit Klemmvorrichtung  
Regelbare monitorarm met klem  
Brazo-soporte para monitor con brida



GZ.0082.M1  
**Braccio portavideo con morsetto**  
Adjustable monitor arm with clamp  
Bras porte-écran avec pince  
Monitor-Trägerarm mit Klemmvorrichtung  
Regelbare monitorarm met klem  
Brazo-soporte para monitor con brida



GZ.0082.M2  
**Braccio portavideo con morsetto, per n° 2 video**  
Adjustable monitor arm with clamp, suitable for 2 monitors  
Bras porte-écran avec pince, pour 2 écrans  
Monitor-Trägerarm mit Klemmvorrichtung, für 2 Bildschirme  
Regelbare monitorarm met klem, voor 2 beeldschermen  
Brazo-soporte para monitor con brida, para 2 monitor



GZ.0060.01 GZ.0060.02  
**Porta monitor con morsetto (singolo-doppio)**  
Monitor stand with clamp (single-double)  
Porte-écran avec pince (simple-double)  
Monitorträger mit Klemme (Einzel-Doppel)  
Monitorsteun met clips (enkele, dubbele)  
Para monitor con borne (individuales, dobles)

**Cassetino sottocrivania - Personal Stationery Drawer under desk - Tiroir sous le bureau - Unterbau-Schublade - Lade onder bureau - Cajón de debajo del escritorio**



TZ.0304.00  
**Cassetino sottocrivania**  
Personal Stationery Drawer under desk  
Tiroir sous le bureau  
Unterbau-Schublade  
Lade onder bureau  
Cajón de debajo del escritorio

**Finiture - Finishes - Finitions - Oberflächen - Afwerkingen - Acabados**

Melaminico - Coated panel - Mèlamine - Melamin - Melamine - Melamina

AL	AC	BL	MH	MO	GP
Alluminio Aluminium Aluminium Aluminium Aluminium Aluminio	Aceró Maple Érable Ahorn Esdoorn Arce	Bianco White Blanc Weiß Wit Blanco	Nebbia Mist Brouillard Nebelgrau Mist Niebla	Tortora Turtledove Tourterelle Turteltaube Tortelduif Tórtola	Grigio Perla Pearl-Grey Gris Perle Perlgrau Parelgrijs Gris Perla
MK	RN	NC	WE	RA	
Nero Black Noir Schwarz Zwart Negro	Rovere Naturale Natural Oak Chêne Naturel Natur Eiche Eikenhout Natuur Roble Natural	Noce Canaletto Canaletto Walnut Noyer Canaletto Canaletto Nussbaum Notenhout Canaletto Nagal Canaletto	Wengé Wengé Wengé Wengé Wengé Wengé	Rovere Anticato Traditional Oak Chêne Vieilli Eiche Antik Oud Eiken Decor Melamine Melamina Roble Antiguo	

Laccato opaco - Matt lacquered - Lacqué mat - Matt lackiert - Matgelakt - Lacado mate

LB	L3	L2	L4	L5	LE
Bianco White Blanc Weiß Wit Blanco	Nebbia Mist Brouillard Nebelgrau Mist Niebla	Tortora Turtledove Tourterelle Turteltaube Tortelduif Tórtola	Titanio Titanium Titane Titan Titanium Titanio	Oceano Ocean Océan Meerblau Ocean Oceano	Deep Teal Deep Teal Bleu Canard Deep Teal Deep Teal Deep Teal
LF	L6	LJ	LN	LA	LR
Verde Natura Gras Green Vert Nature Grasgrün Groene Natuur Verde Naturaleza	Verde Muschio Moss Green Vert Mousse Moosgrün Mosgroen Verde Musgo	Giallo Gold Yellow Gold Jaune Or Goldgelb Geelgouden Oro Amarillo	Nero Black Noir Schwarz Zwart Negro	Alluminio Aluminium Aluminium Aluminium Aluminium Aluminio	Bordeaux Bordeaux Bordeaux Bordeaux Bordeaux Bordeaux

Strutture metalliche - Metal structures - Structures métalliques - Metallstrukturen - Metalen structuren - Estructura metálicas

AF	BW	TF	NF	KR
Epoxy Alluminio Silver Epoxy Epoxy Aluminium Aluminium Aluminiumkleur Epoxidica De Aluminio	Bianco White Blanc Weiß Wit Blanco	Tortora Turtledove Tourterelle Turteltaube Tortelduif Tórtola	Nero Black Noir Schwarz Zwart Negro	Cromo Lucido Glossy Chrome Chromé Brillant Chrom Poliert Glanzend Verchromd Cromo Pulido

Tessuto - Fabric - Tissu - Stoff - Stof - Tejido

	PV	P4	P8	P2	PG	P1
<b>Puma</b> A + B						
	Verde Mela Apple Green Vert Pomme Apfelgrün Appelgroen Verde Manzana	Bordeaux Bordeaux Bordeaux Bordeaux Bordeaux Bordeaux	Blu Dark Blue Bleu Blau Blauw Azul	Grigio Medio Medium Grey Gris Moyen Mittelgrau Gewoon Grijs Gris Harmigón	Grigio Scuro Dark Grey Gris Foncé Dunkelgrau Donkergrijs Gris Oscuro	Nero Black Noir Schwarz Zwart Negro
	A1	A2	A3	A4	A5	A6
<b>Lucia</b> A + B						
	Sabbia - Aruba Sable - Aruba Sable - Aruba Sandfarbe - Aruba Zand - Aruba Arena - Aruba	Matrone - Jamaica Brick-Coloured - Jamaica Brique - Jamaica Ziegelrot - Jamaica Baksteen - Jamaica Pardo Cobre - Jamaica	Celeste - Arcibo Light Blue - Arcibo Bleu - Arcibo Hellblau - Arcibo Hemelsblauw - Arcibo Azul Celeste - Arcibo	Blu - Martinique Blue - Martinique Bleu - Martinique Blau - Martinique Blauw - Martinique Azul - Martinique	Petrolio - Windjammer Petroleum - Windjammer Pétrole - Windjammer Petroleum Blau - Windjammer Petroleum - Windjammer Petróleo - Windjammer	Testa Di Moro - Sombrero Dark Brown - Sombrero Brun Gris - Sombrero Dunkelbraun - Sombrero Donkerbruin - Sombrero Pardo Grisáceo - Sombrero
	Y1	Y2	Y3	Y4	Y5	Y6
<b>Stay</b> B						
	Giallo Yellow Jaune Gelb Geel Amarillo	Arancio Orange Orange Orange Oranje Naranja	Verde Green Vert Grün Groen Verde	Celeste Light Blue Bleu Hellblau Hemelsblauw Azul Celeste	Blu Avio Air Force Blue Bleu Aviation Avio Blau Avio-Blauw Azul Colombino	Grigio Londra London Grey Gris Londres London Grau Londen-Grijs Gris Londres
	X1	X2	X3			
<b>Xpress</b> B						
	Giallo Primavera Spring Yellow Jaune Printemps Frühling Gelb lentegeel Amarillo Primavera	Verde Sottobosco Underwood Green Vert Sous-Bois Unterholz Grün Bosgrond-Groen Verdes Sotobosque	Blue Jeans Blue Jeans Denim Blue Blue Jeans Blau Jeansblauw Azul Denim			

<b>A</b>	<b>B</b>
Per sedute For armchair Pour les chaises Für Stühle Voor stoelen Para las sillas	Per schermi For screens Pour écrans Für Schirmwände Voor schermen Para las pantallas